



Yellow Products

FACILITY ASSET PROTECTION



SAFETY PRODUCTS
LEAD FREE PAINT
MADE IN U.S.A.

New Products:
Page 3



Save Your Assets

- People
- Products
- Equipment
- More



IN STOCK

"Save'ty" Stand Guard Rails & Systems



Protecting The Supply Chain.



Yellow Products

FACILITY ASSET PROTECTION



SAFETY PRODUCTS
LEAD FREE PAINT
MADE IN U.S.A.

New Products:
Page 3



Save Your Assets

- People
- Products
- Equipment
- More



IN STOCK

"Save'ty"® Stand Guard Rails & Systems



Protecting The Supply Chain.



Yellow Products

FACILITY ASSET PROTECTION



SAFETY PRODUCTS
LEAD FREE PAINT
MADE IN U.S.A.

New Products:
Page 3



Save Your Assets

- People
- Products
- Equipment
- More



IN STOCK

"Save'ty" Stand Guard Rails & Systems



Protecting The Supply Chain.

"Save"ty[®] Yellow Products

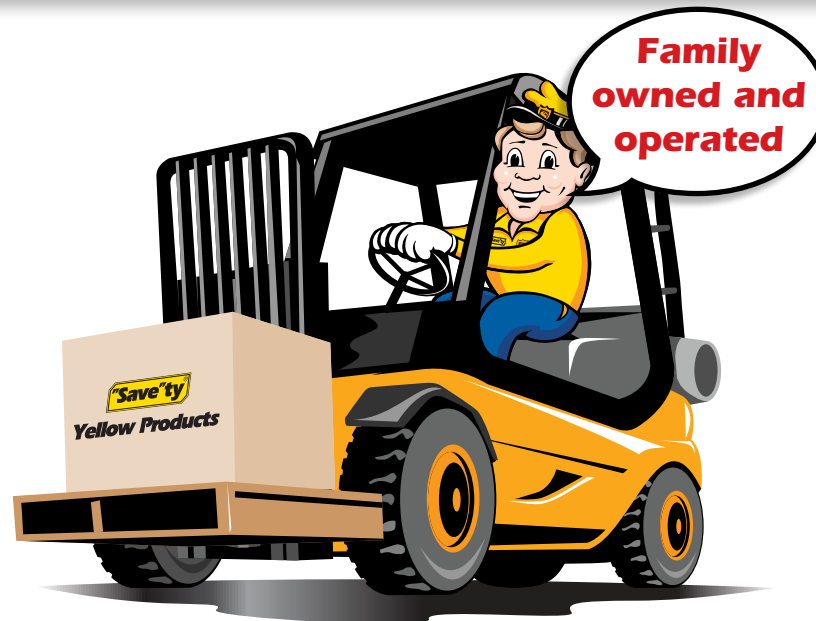

We Deliver MORE Than Just Our Products!

We Deliver PEACE OF MIND!

Without "Save"ty Yellow Products, you may be worrying more about safety issues than you should be.

You have invested in your business – equipment, inventory, and especially employees – to meet the needs of your customers. You don't want unexpected safety issues to cause you downtime, added expense, or personal injury. Let "Save"ty Yellow Products help protect your business and **SAVE YOUR ASSETS!**

Our products have been shown to protect employees, facilities, products, and equipment from impact with fork trucks, and do it better and at a lower cost! We have supplied products to facilities used by some of America's finest companies, including Amazon, U.S. Foods, Adidas, Home Depot, and General Electric.

Built on the foundation of "The Original **LIFT-OUT Sleeve Design**" guard rail system, "Save"ty Yellow Products has branched out to include facility protection, hand

rails, safety gates and more. We continue to develop new products to meet safety needs and also customize products for specific applications.

The products we manufacture are made in America, powder coated with certified lead-free paint, and stocked in Illinois.

We invite you to enjoy the peace of mind that comes from knowing that your business is protected 24/7. "Save"ty Yellow Products can help you do that!

– The Gentile Family

The little things matter...



In Stock



Quality



Packaging



New Additions

NEW FOR 2020

Rolling Gate

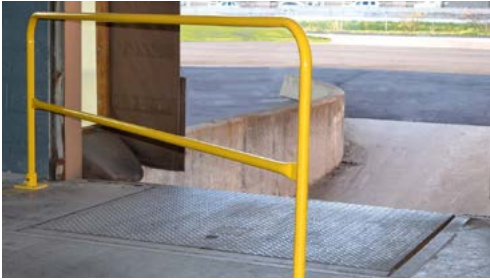

Economical **Rolling Gate** for customers on a budget. See page 13.

Fabric Gate

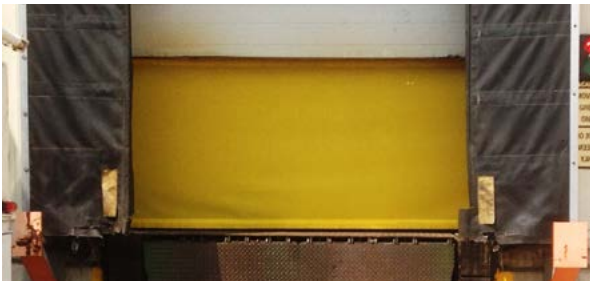

Retractable **Fabric Gate** for customers who want to let in a little air and have security at the same time. See page 14.

Rack Deflect

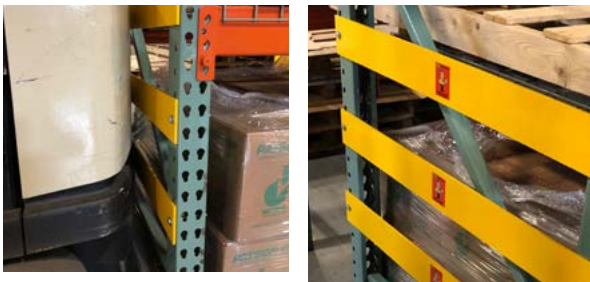

Rack Deflect was designed to block side frame damage. See page 11.

Pallet Guide



Pallet Guide steers pallets into place without hitting the rear of the frame. Also works as a frame brace. See page 11.

Dock Stop HD



Dock Stop HD, our strongest Dock Gate yet. See page 17.

Back of Rack



Back of Rack stops product from being pushed off the rack. See page 12.

Roofguard



Roofguard See page 13.

Pivot Gate



Pivot Gate creates ideal mezzanine protection while allowing for easy pallet loading and unloading. See Page 23.



Double corner post



Inline post



Optional offset end post

Ribbed Rail "Stand Guard"

Our most popular item: the **Stand Guard** ribbed rail. "The Original **LIFT-OUT** Sleeve Design" reduces installation cost by half!

- Sleeves are welded to posts, **no costly brackets as an afterthought.**
- 4" posts with 10" x 10" x 1/2" base rated for impacts up to 10,000 lbs at 5 mph.
- 5" posts with 10" x 10" x 5/8" base rated for impacts up to 12,000 lbs at 5 mph.
- Painted steel caps are included with posts.
- Post heights: 18", 26" & 42".
- 10-gage, high-tensile steel rails fit either post.
- Rails are 2' through 10' in 1' increments.



FULLY WELDED SLEEVES!



Offset posts are in stock.

Guard Rails



Lite ribbed guard rail



Create a pedestrian walkway with Stand Guard Lite

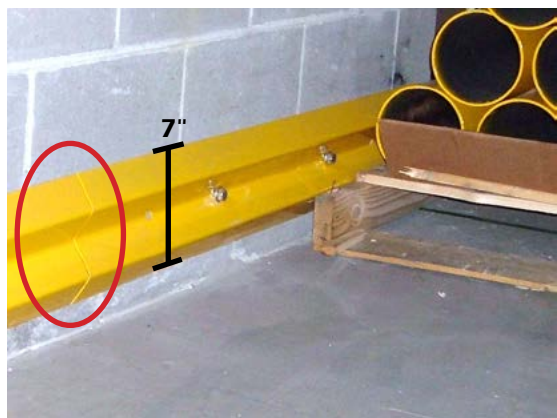

Quick Release LIFT-OUT design

Lite Duty Guard Rail

"Stand Guard" Lite is designed for powered and manual stackers, electric pallet trucks, steel carts & hoppers, etc.

- A great alternative to high strength guard rail, with *The Original LIFT-OUT Sleeve Design*.
- Designed for heavy impacts up to 5,000 lbs. at 5 mph.
- 4" posts, 18" & 42" high, with 8" x 8" x 1/2" base.
- 14-gage, high-tensile steel rails are 2' through 10' in 1' increments.



Wall Bumper Rail

Durable Steel Protection

- Mounts directly to wall on 16" centers
- 14 gage steel
- 2', 4', 6', and 10' lengths available
- Eliminate posts along perimeter walls
- Can be overlapped to reduce cutting in the field

Twin Rail

Durable steel protection

- Our original Twin Rail design from 2003 re-styled with stronger rails. It comes standard with **LIFT-OUT** rails that offer holes for bolting together if desired.
- Create a mezzanine gate with twin rail, utilizing the Quick Release LIFT-OUT design.
- 44" tall posts with a powder coated steel cap.
- 3" x 3" posts, with a 6" x 6" x 1/2" base plate is rated for 4000 lbs. impact at 4 mph.
- 4" tall x 2" wide rail is 11-gage high-tensile steel.
- Top rail is 42" high
- **MEETS OSHA REQUIREMENTS.**
- Available in 4', 6', 8' and 10' lengths.



Slim & short models



Eagle™ – Velcro™ strap



The Original **LIFT-OUT** Sleeve Design is available in single-rail height



Building and Mezzanine Column Protectors

Prevent damage to building support columns or mezzanine columns. From Eagle™ Mfg.

- **SHORT** Model is 24" tall x 24" wide for 6", 8", 10" & 12" columns, Yellow or Red.
- **SLIM** Model is 42" tall x 12" wide for 4", 5", & 6" columns, Yellow.
- **STANDARD** Model is 42" tall x 24" wide for 6", 8", 9" Round, 10", & 12" columns. Yellow standard, Lime Green or Orange with reflective tape also available.
- **FASTENERS** Velcro straps.
- **SHIPPING POINTS** Five shipping warehouses.
- Impact Rating – 8000 lbs @ 5 M.P.H."



Style	Eagle™	Colors
SHORT	6", 8", 10", 12"	Yellow, Red
SLIM	4" - 6"	Yellow
STANDARD	6", 8", 9" Round, 10", 12"	Yellow, Orange, Lime Green
FASTENER	Velcro Strap	Black

Protect Your Building Columns & Downspouts with Stand Guard Rail

Our most popular item: the **Stand Guard** ribbed rail. All welded **DROP-IN, LIFT-OUT** design standard.

- Sleeves are welded to posts, **no costly brackets as an afterthought.**
- Post heights: 18", 26" & 42"
- Rails are 2' through 10' in 1' increments.



Column Protectors

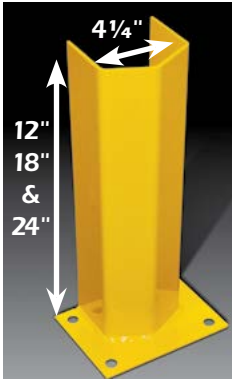

"V" face

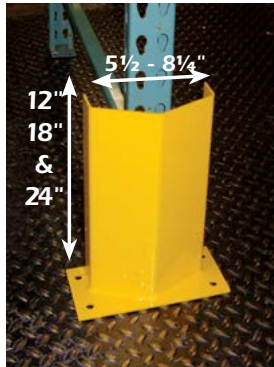

Seismic

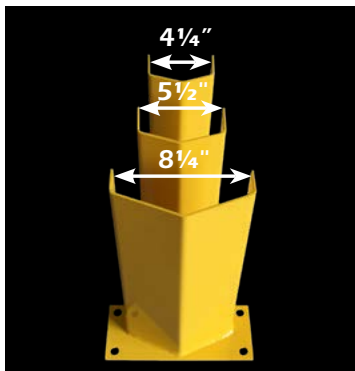

3 different heights & widths



Poly post protector



Corner Protector

**14,000
In Stock!**

Traditional Post Protectors

Traditional style post protection available in a "V" shape or formed face.

- Traditional style with four mounting holes.
- Choose from 12", 18", & 24" tall.
- Clear opening: 4 1/4".
- Anchors available upon request.

Seismic Post Protectors

Seismic post protectors in "V" face style designed to fit around seismic footplates.

- Clear opening of 5 1/2" or 8 1/4".
- Choose from 12", 18" or 24" tall.
- Base plate is 5" deep with four mounting holes.
- Anchors available upon request.

Poly Post Protectors

Easy snap on installation.

- Fits 3" x 1 5/8" or 3" x 3" rack.
- 8" tall x 5 1/2" O.D. wide.
- Stackable.

Corner Protector

- Protect corners.
- 4" x 4" x 18" tall.
- 4 mounting holes.
- Accepts 1/2" anchors.





Bolt On



Side mount



Closed top for food industry



Flush hardware



Bolt On Post Protectors

Bolt-on post protectors add strength to frame column to prevent costly rack damage.

- Available in 18" tall with a clear opening 3 1/8".
- 3/16" thick wall.
- Optional hardware to attach to rack frame.
- Add strength to your upright.
- Mounting hole inside 1/4" thick bull nose.
- Accepts 5/8" anchor (additional).



Side Mount Frame / Column Protectors

Stop damage at every level.

- Increase frame strength.
- No base plate to interfere when storing pallets.
- 3 1/4" clear opening.
- 12" and 24" tall with 2" hole spacing.
- Mounting hardware included.

Food Industry Closed Top Post Protectors

New food industry closed Top Post/Column Protector

- 24" tall with closed top.
- Side mount with open/notched back for first beam level.
- 3 1/4" clear opening.
- 24" tall with 2" hole spacing.
- Mounting hardware included.



Post Protectors



Outrigger post protector

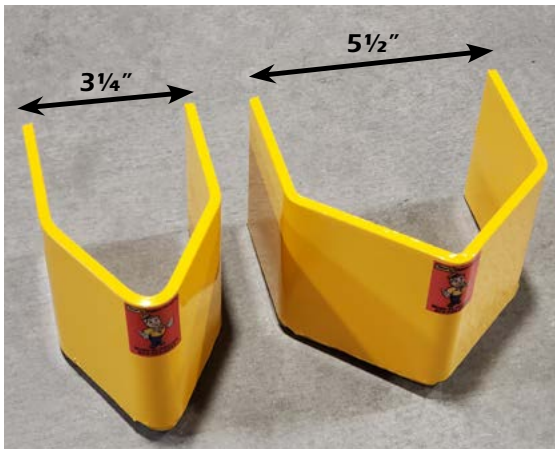

1/4" or 3/8" in stock



Post Protector No Base

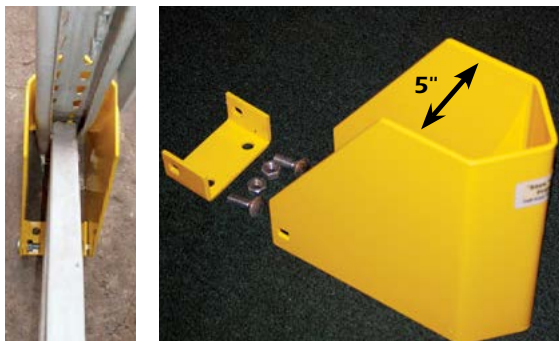

Patented

Outrigger Post Protectors

Designed specifically for Outriggers.

- Choose from 1/4" or 3/8" thickness.
- 4" tall x 3.25" clear, or 5.5" available.
- One mounting hole behind face.
- Accepts 5/8" anchors.



Post Protector No Base

- Formed from one plate of steel.
- Fits 4 1/4" or 5 1/2" clear opening.
- 3/4" clearance at the bottom.
- Accepts 1/2" anchors.



Hidden Anchor Post Protectors

Rack column post protectors eliminate base plates.

- Bolt down model with bracket hardware.
- Energy absorbing design anchors securely in front & behind frame.
- 12" tall by 9" deep.
- Inside dimensions are 5" x 5".
- TAPCON anchors available upon request.

End of Aisle Guards



Seismic option



Half curved end
(right hand pictured)



Double E.O.A.

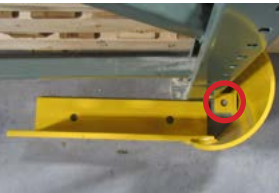

Three
mounting holes



Strong
corner protection



Rack Guard Round
Protects your warehouse



End of Aisle Rack Protection Curved End

Rack protection creates a visible guide through aisles and saves thousands in damage.

- Available in 36", 42" & 48", single or double ends.
- Custom sizes available.
- Curved end has an 8" I.D. x 12" tall.
- Choose floor angle thicknesses of $\frac{1}{2}$ ", $\frac{3}{8}$ ", and $\frac{1}{4}$ ".

Super Duty Rack Guard

Three mounting holes.

- Our strongest rack guard yet with an extra mounting hole behind the curved face.
- 18" long with 6" x 4" x $\frac{1}{2}$ " steel angle.
- Has two mounting holes on the angle and one behind the nose.

Rack Guard Round

Solid welded construction.



- Fits snug to frame.
- Three $\frac{1}{2}$ " thick feet create an overall height of 5".
- Accommodates seismic foot plates up to 8" deep.
- 36", 42" or 48" O.A.L., with closed ends.
- Custom sizes available.

Pallet Stop

Prevent wall and product damage.

- 18" long x 5" tall, centered between rack frame, protects two skids at the same time.
- Anchors to the floor with two legs on either side of frame.
- Mounting feet may be mounted against the wall / Plastic end caps optional.



Rack Deflect and Pallet Guide



Reinforces rack and protects from impact



Flush hardware



Use as a pallet guide, reduces rack damage



Pallet guide or rack reinforcement

Rack Deflect

Prevents potential damage to crossbars by creating a barrier between the crossbars and forklifts.

- 4" tall x ¼" thick steel bars
- Steel bars can be stacked to create ½" thickness for additional strength.
- Available in 42" and 48"
- Mounted flush using double-end stud and weld nut so that nothing 'catches' on the hardware (see image below).
- Easy installation.
- Multiple bars can be used as bracing for the rack, providing reinforcement to the rack.



Pallet Guide

Prevents potential damage to crossbars and rack corners from pallets by creating a guide for pallets.

- 4" tall x ¼" thick steel bars.
- Available in 42" and 48"
- Mounted flush using double-end stud and weld nut so that nothing 'catches' on the hardware (see image below).
- Multiple bars can be used as bracing for the rack, providing reinforcement to the rack.
- Hardware included.

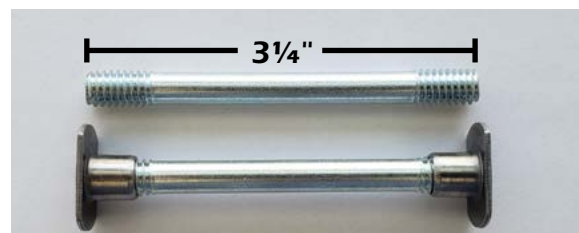

Flush mount hardware

Rack Protection



Front tab removes pressure from hardware

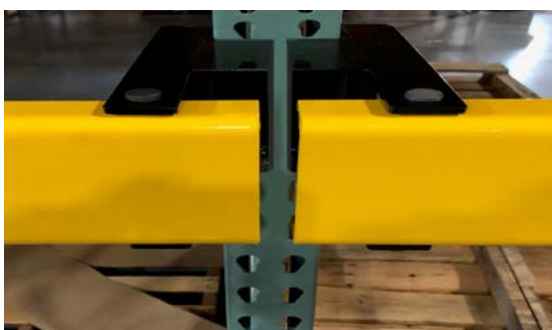

Pallet Guide / Stop

- Two products in one! – Keeps flue space clear and prevents damage to walls behind rack.
- 4" tall x ¼ thick steel bar with 10" return
- Available in 42", 45" (42" with 3" overhang), 48", and 51" (48" with 3" overhang).
- Mounts flush to double-end stud and weld nuts so that nothing "catches" on the hardware – see bottom of page 11 for hardware.
- Easy installation – hardware included.
- Creates additional reinforcement for the rack.
- Available without rear stop – see page 11.



Back of Rack

Designed to stop employees from pushing a skid off the back of the rack.

- High tensile steel brackets are 10 gage and are bolted to frames.
- Strong horizontal braces are secured in place with a ½" thick pin.
- Cut installation costs in half because there is no need for heavy netting, or the extreme hassle of netting installations.
- Low maintenance compared to broken straps, broken mesh panels and torn netting.
- Bracket measures 6" off the frame.
- This 10 gage thick brace is 4" tall, 97½" in length and is formed into a "C" channel for strength. See side profile above.
- ½" bracket hardware included.
- Use multiple braces for loose carton areas.
- Stocked in 8' sections, covering two pallet positions.
- Can be used in a back-to-back rack design to protect product from damage.



Perimeter Protection

Rooftop Perimeter Protection (Roofguard)

Roofguard is a versatile, rooftop fall protection system

- Free-standing, non-penetrating system with lightweight base plates.
- Can be used in both permanent and portable applications.
- Fast and easy installation – no drilling or special fasteners required.
- Available in 6', 8', and 10' handrail sections.
- **MEETS OSHA REQUIREMENTS.**
- Wind load tested.
- Can also be used on metal roof systems.



Interior Perimeter Protection

Perimeter protection products can save you thousands from lift trucks bumping into walls, door tracks, water and electrical pipes. Protect your facility today for much less than the cost of damage.



Fabric Savety Gate

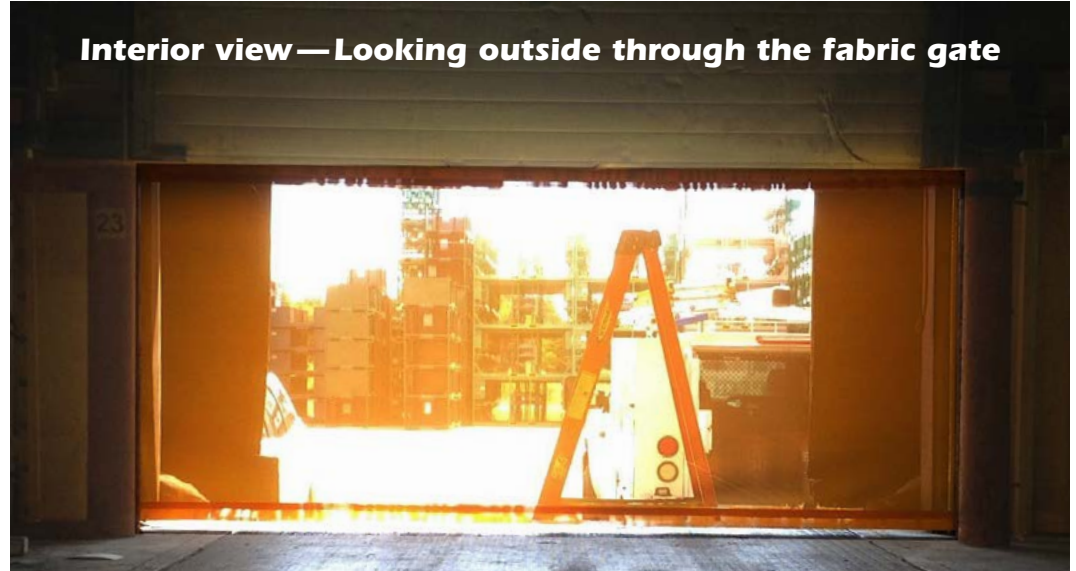

Our Fabric Savety Gate is perfect for dock doors that are often open. The Fabric Gate protects against unwanted visitors, insects, birds, and debris from entering the work area while allowing air to flow through. Our design allows for easy operation, requiring just 3 lbs of pull force to extend the gate. A locking feature prevents unwanted entry and theft.

- Accommodates doors from 8' – 16'
- High visibility
- Breathable fabric lets air circulate
- Small gap at base of the gate
- Easily retracts, requiring only 3 lbs of pull force



- Ratchet mechanism controls tension
- Locking feature included to prevent unwanted entry
- 48" tall
- **MEETS OSHA REQUIREMENTS.**
- Impact rating — 1000 lbs @ 4 M.P.H.

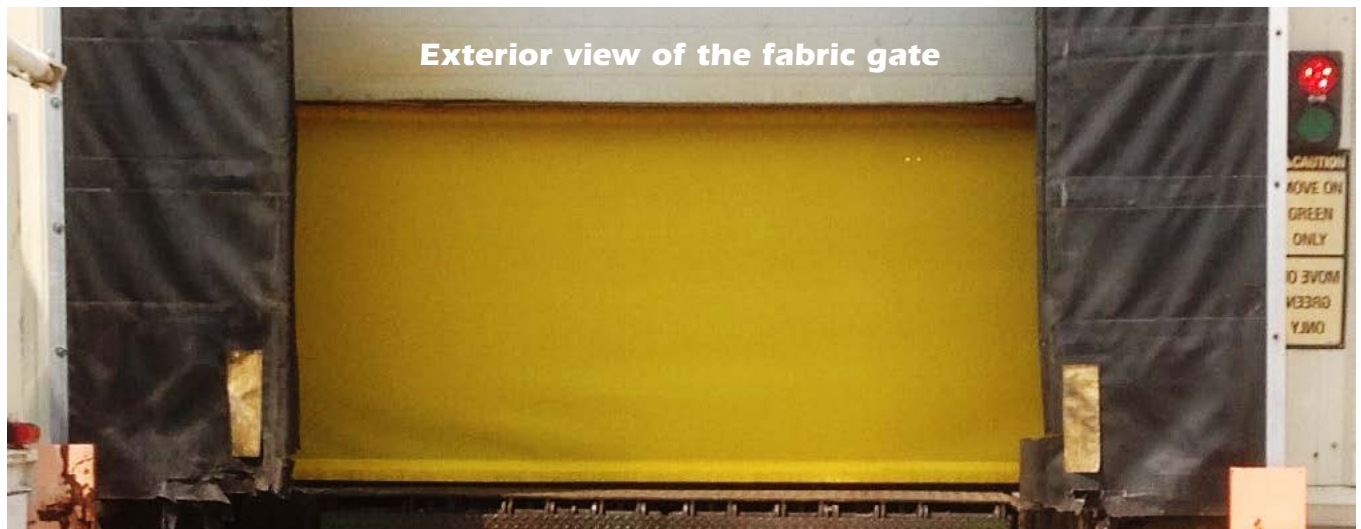

Dock Gates



Rotating gates: widths from 4' to 14'



Open dock



Locking Caster

Interior View



Exterior View

Rotating Dock Gate

Provides security, creates awareness and fall protection.

- Mounts over a 42" tall bollard which is required.
- Choose widths from 4' to 14'.
- Install two gates to meet in the center to accommodate space restrictions if needed.
- Add an optional bollard with eyelet at the opposite end for security.



Rolling Dock Safety Gate

Permits safe access in and out of the loading dock area with easy access and no lift and pinch hazards.

- Available in 8', 10', and 12' sizes.
- Durable 1.66" O.D. steel.
- Powder coated safety yellow.
- **MEETS OSHA REQUIREMENTS.**
- Rolling design eliminates lifting and pinch hazards.
- Mounting hardware optional.
- Locking caster stops drift.
- Easy installation – anchor base in minutes and you're done.



Dock Stop Lite



Patent Pending



Slide Bar Handle and Locking Pin

CREATE A REAL BARRIER

- Stop fork trucks from driving or backing off the dock
- Dock Stop includes two rotating arms
- Includes two 42" bollards with 10" x 10" x 1/2" base plates
- Locking slide bars with locking pin
- Impact rated for 4000 lbs at 4 mph
- 8', 9', 10', 11' and 12' door sizes in stock
- Built in height-levelers, so arms meet in the middle every time
- Powder coated safety yellow
- Include reflective 'Stop' signs



Dock Stop Heavy Duty

OUR STRONGEST DOCK GATE EVER! DOCK STOP *HD*

- Oversized 12" x 12" x 5/8" base plates with gussets for strength
- No pinch points when gate is closing
- 5" steel posts powder coated steel caps
- Robust 1" pins support gate arms
- Adjustable wrap around plate bolts to post to support gate arms
- Reinforced cross bar for strength behind panels
- 42" tall
- **MEETS OSHA REQUIREMENTS.**
- Impact rating — 10,000 lbs. @ 5 M.P.H.



Patent Pending

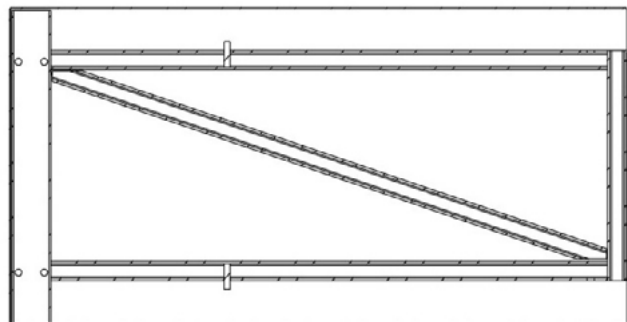

Reinforced Cross Bar



Dock Door Gates

Ideal for overhead doors. Great visibility to prevent accidents.

The "Save"ty Yellow Dock Gate is fabricated and bolts to post creating visibility. It is an economical and simple solution to comply with OSHA fall protection.

- Available in an 8', 10' and 12' clear opening.
- All sizes in stock.
- 42" tall at top of rail.
- New locking-pin design prevents gate from dropping.
- Air actuation cylinder holds gate open during deliveries or shipments.

Lift Gates: 8', 10' & 12' clear opening

▪ **MEETS OSHA REQUIREMENTS.**

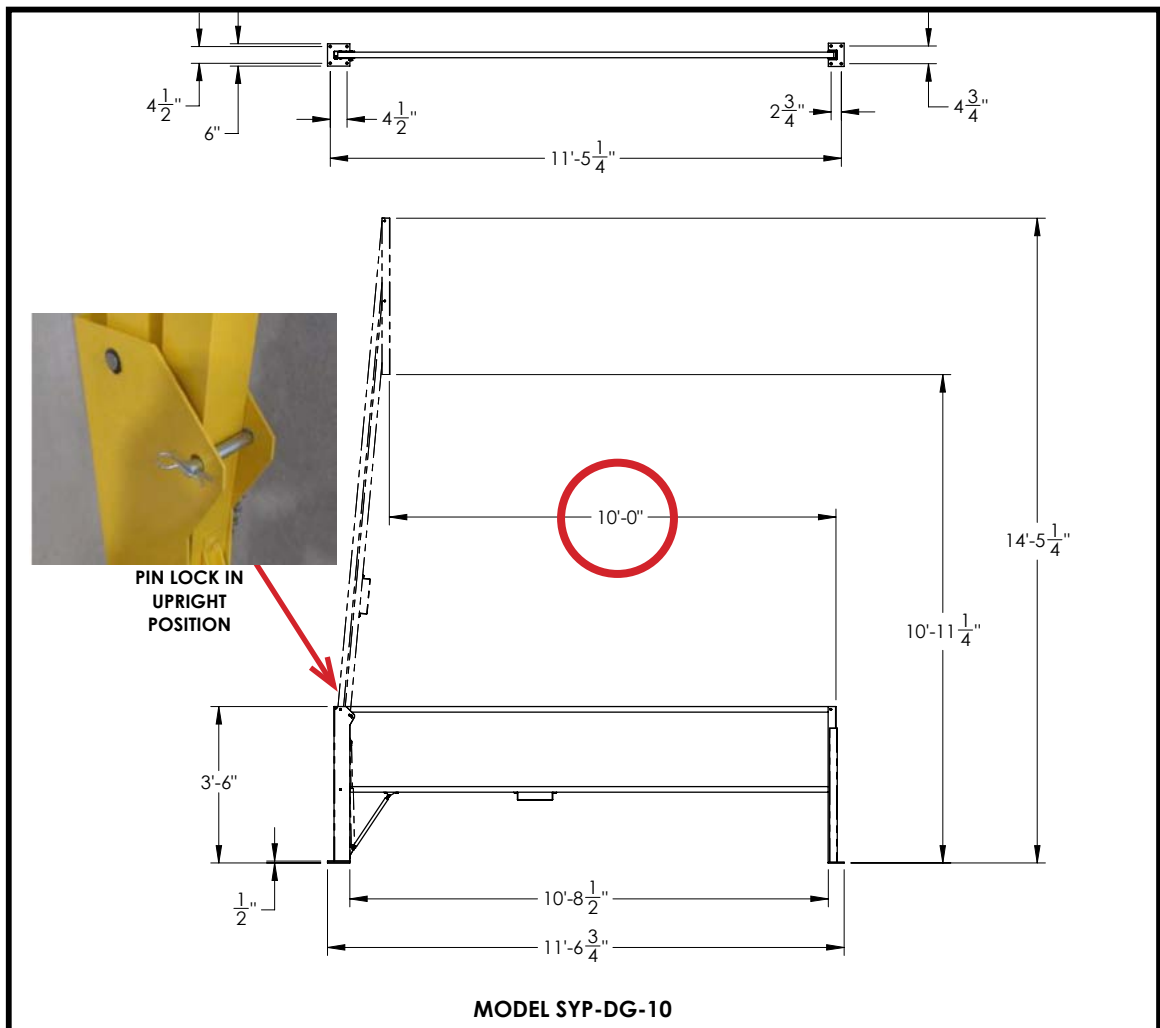

Hand Rails and Door Track



Indoor



Outdoor

Hand Rails

Modular hand rail protects employees from entering areas that are unsafe.

- Rails are powder coated yellow for long lasting durability.
- Easy installation, simply assemble and anchor down.
- Easy replacement of damaged sections or relocation.
- Stocked sizes: 4', 6', and 8' sections; can be cut down in the field.
- 1.66" O.D.
- **MEETS OSHA REQUIREMENTS.**
- 42" tall standard, ADA available.
- Fittings for mezzanine installation available.
- 1/8" kick plate (4" x 2") – In Stock.

Galvanized cast iron fittings

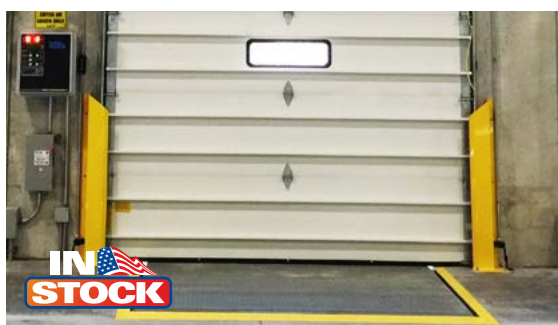

Door Track Protectors

Door Track protects overhead door track from damage while placing or retrieving pallets.

- Available with or without safety bevel.
- Eliminates expensive service calls for door repair.
- Available without baseplate.
- Standard duty for fork truck and commercial applications.
- Full 7" depth, up to 14" available.
- 36" and 48" tall in stock.
- 3/16" material, 1/4" base
- 1/4" available

Bollards



Stand Guard square bollards



White Reflective Band Available



Direct bury bollards

Steel Bollards

Steel bollards protect a variety of facility assets.

- Surface mount to concrete or Direct Bury.
- **Economy** 4.5" O.D., Yellow or Red, 5.5" O.D., Yellow only, 24," 36" or 42" tall.
- **Standard** 4.5" O.D. 42" tall, Yellow with black plastic cap; or 6.5" O.D. 24", 36" or 42" tall, Yellow with welded top, available with welded eyelet.
- **Direct Bury** 5.5", 6.5" & 8.5" O.D. 84" tall, Yellow.
- **Square Bollard** 4" square tube. 42" tall with painted steel cap.
- White reflective band available on any size bollard.

SAFETY PRODUCTS
LEAD FREE PAINT
MADE IN U.S.A.



We Have Your Bollards! Ready To Ship!

FAST DELIVERY

SURFACE MOUNT				
OD	HEIGHT	BASE	COLOR	TOP
4.5"	24", 36", 42"	8x8x1/4	Yellow	Plastic cap
5.5"	24", 36", 42"	8x8x1/4	Yellow	Plastic cap
6.5"	24", 36", 42"	9x9x1/2	Yellow	Welded
IN GROUND BOLLARDS				
OD	HEIGHT	BASE	COLOR	TOP
5.5"	84"	NONE	Yellow	OPEN
6.5"	84"	NONE	Yellow	OPEN
8.5"	84"	NONE	Yellow	OPEN

POWDER COATED TOUGH™



Safety Swing Gates



Great for stair openings



Double gate has built-in stop



Gate rotates 90° to open and stays upright until closed



Safety Swing Gates

Ideal for stair openings, ladders and platforms. The "Save"ty Swing Gate bolts to existing rail opening to provide a one-way, self-closing gate. It is a simple and economical solution to comply with OSHA.

Single & Double Gate

- Each gate has 2½" adjustability.
- Double Gate has built in stop.
- Single Gate requires a post for strike plate.
- Designed to fit hand railings.
- **MEETS OSHA REQUIREMENTS.**

Swing Gate No.	Fits Clear Opening	Wing Gate Part #	Fits Clear Opening
SINGLE GATE		DOUBLE GATE	
SYP-PS-15	14" - 17.5"	SYP-PS-9D	16" - 22.5"
SYP-PS-18	17" - 20.5"	SYP-PS-12D	22" - 28.5"
SYP-PS-21	20" - 23.5"	SYP-PS-15D	28" - 34.5"
SYP-PS-24	23" - 26.5"	SYP-PS-18D	34" - 40.5"
SYP-PS-27	26" - 29.5"	SYP-PS-21D	40" - 46.5"
SYP-PS-30	29" - 32.5"	SYP-PS-24D	46" - 52.5"
SYP-PS-33	32" - 35.5"	TELESCOPING GATE	
SYP-PS-36	35" - 38.5"	SYP-TEL	18" - 36"
SYP-PS-40	39" - 42.5"		
SYP-PS-44	43" - 46.5"		
SYP-PS-48	47" - 50.5"		

Lift A Gate

- Bolt to any standard guardrail, regardless of brand.
- Available in 36", 42", and 48"
- Self-closing option coming soon!
- Manual lift, manual close standard.
- Mounting instructions include a template for drilling through post.
- Cylinder rated for 10,000 cycles.
- Handrail kit coming soon!

Telescoping Swing Gate

- Adjusts to fit opens from 18" to 36".
- Can be installed on guardrail or handrail (2" O.D. max), regardless of brand.
- Can be inverted to swing either left or right.
- Springs designed for over 1 million cycles.
- Self closing.
- **MEETS OSHA REQUIREMENTS.**



PickerPal gate



Great 360 degree mezzanine protection



Bumper style

Mezzanine Safety Gates

We have five different styles of Mezzanine gates available to meet your needs — all are designed with fall protection per OSHA guidelines!

PickerPal Mezzanine Gates

- 6 self closing arms, operate independently.
- 6' or 8' width.
- Includes 8' tall rack frames and height limiter.
- **MEETS OSHA & IBC REQUIREMENTS.**

SafetyMezz360

For mezzanines or pick modules.

- Comes with 60" or 100" clear opening.
- Includes 4" safety toeboard.
- **COMPLIES WITH OSHA AND ANSI STANDARDS.**
- Utilizes a counter-balanced gate system and includes a slam-proof design.
- Easy to install and allows for one-handed operation.

Pallet Gate with Bumpers

- Standard Sizes: 60" or 72" clear opening width and clear opening height up to 84", includes gate columns, three (3) springs per gate, housed within hinge pivot.
- Teardrop Impact Bumpers: High-impact, ABS bumpers with 3" projection. Black.
- Specifications: High-impact, ABS adjustable 4" toe boards.
- **MEETS OSHA REQUIREMENTS.**

Mezzanine Gates



Horizontal sliding gate



Vertical lift gate

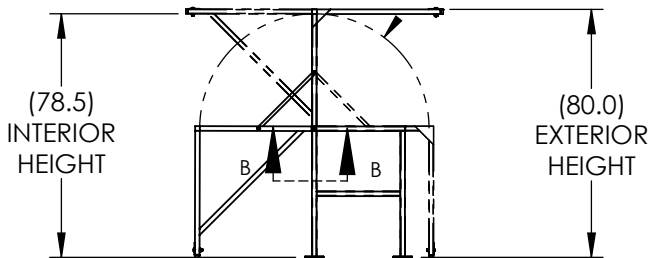

Pivot gate – closed

Mezzanine Gates

The Horizontal Sliding Gate and the Vertical Lift Gate are designed to be durable, productive, provide the same protection as your railing systems, and meet federal OSHA requirements for standard railings.

- Easily slides open and closed.
- Manufactured to specific width requirements.
- Factory welded steel framework.
- Gates are 42" high, with one mid-rail and 4" toeboard.
- Electric or pneumatic operation available with remote control. Call for details.
- Easy Installation.
- **MEETS OSHA REQUIREMENTS.**



Pivot Gate

Single or Double width gates.

- Choose from 60", 65", 72" 96" or 120" clear opening.
- All welded tubular steel frame.
- Easily pivots to up or down position.
- Requires only 10-20 lbs. of lift force.
- Made to order to fit your specific opening.
- Ships mostly assembled – minor assembly required upon receiving and simply anchor to mezzanine floor.
- Adjustable kickplate and rubber feet.
- **MEETS OSHA REQUIREMENTS.**



Flat Top



Dome Top

Blue Light

Increase warehouse safety by adding a Blue Light to increase visibility and awareness of fork trucks.

- Mount to fork truck (front or rear).
- Hardware and 12" wire lead provided.
- 5 bright LED lights create 400 Lumens of bright blue light in the path of the fork truck (subject to change).

Fork Extension Bracket

Stop looking for a place to put your fork extensions!

- Holds up to 3 fork blade extensions.
- Can be wall or rack mounted, hardware not included.
- Solid high tensile steel construction for long-lasting durability.
- Measures 6" wide x 8" tall, hook extends out 5".
- Powder coated Savety Yellow.

Bollard Sleeves

- Made using a 1/8" thick High Density Polyethylene plastic, the sleeves are designed to absorb impact, be solvent resistant, resist fading in ultraviolet light, and can withstand extreme temperatures.
- On the Flat Top sleeves, 3M reflective stripes increase visibility.
- Mounting kit included at no charge.
- Dropship direct to your customer.
- Available in 4½" – 12¾" diameter.
- Sleeves can be cut to size at no charge.
- Choose from Flat Top or Dome Top sleeves.
- Sleeves slide on quickly and easily, no hassle.

Flat Top		Dome Top	
I.D.	Height	I.D.	Height
4.5"	52"	4.5"	52"
4.5"	64"	4.5"	64"
7"	52"	7"	52"
7"	60"	7"	60"
7"	72"	7"	72"
8-7/8"	72"		
8-7/8"	60"		
11-1/3"	60"		



Our Products at Work

Application Photo Gallery

Applications are indispensable when you consider the value of assets that need protection.

Our products secure many areas and stand guard to protect the facilities and employees of small, medium and large corporations.

If you have an application that you would like to discuss, we will help you find the best solution to fit your needs. We have the experience and resources to assure that you and your facility will remain protected.

At "SAVE"ty Yellow Products it's our mission to help SAVE YOUR ASSETS!



Guarding equipment

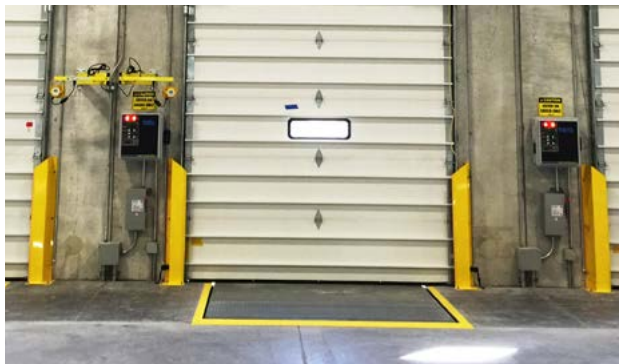

Door track guards



Guarding battery racks



Guarding electrical panels



Guarding refrigeration



Guarding employees behind drywall

"Save"ty[®] Yellow Products



Protect vulnerable access points

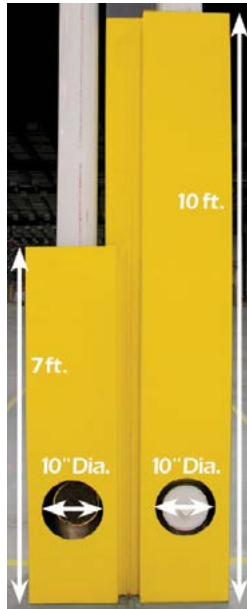

Custom made



Building Column & Downspout Guard Rail



See pages 4 and 21



See page 15

Our Products at Work



Perimeter protection and rack guard



Drive thru rack protection



Lift up and out of the way



Strong end of aisle rack protection with offset baseplates



Create a safe passage



We Deliver MORE Than Just Our Products!

We Deliver PEACE OF MIND!

Without "Save"ty Yellow Products, you may be worrying more about safety issues than you should be.

You have invested in your business – equipment, inventory, and especially employees – to meet the needs of your customers. You don't want unexpected safety issues to cause you downtime, added expense, or personal injury. Let "Save"ty Yellow Products help protect your business and **SAVE YOUR ASSETS!**

Our products have been shown to protect employees, facilities, products, and equipment from impact with fork trucks, and do it better and at a lower cost! We have supplied products to facilities used by some of America's finest companies, including Amazon, U.S. Foods, Adidas, Home Depot, and General Electric.

Built on the foundation of "The Original **LIFT-OUT Sleeve Design**" guard rail system, "Save"ty Yellow Products has branched out to include facility protection, hand

rails, safety gates and more. We continue to develop new products to meet safety needs and also customize products for specific applications.

The products we manufacture are made in America, powder coated with certified lead-free paint, and stocked in Illinois.

We invite you to enjoy the peace of mind that comes from knowing that your business is protected 24/7. "Save"ty Yellow Products can help you do that!

– The Gentile Family

The little things matter...



In Stock



Quality



Packaging



New Additions

NEW FOR 2020

Rolling Gate

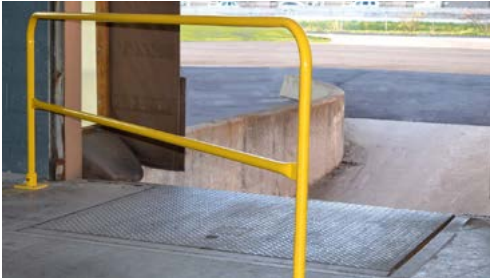

Economical **Rolling Gate** for customers on a budget. See page 13.

Fabric Gate

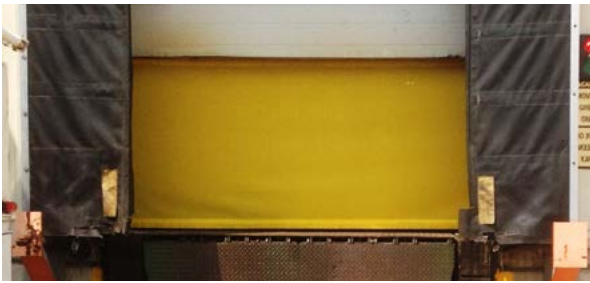

Retractable **Fabric Gate** for customers who want to let in a little air and have security at the same time. See page 14.

Rack Deflect

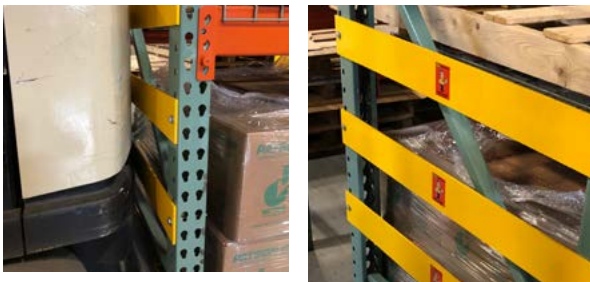

Rack Deflect was designed to block side frame damage. See page 11.

Pallet Guide



Pallet Guide steers pallets into place without hitting the rear of the frame. Also works as a frame brace. See page 11.

Dock Stop HD



Dock Stop HD, our strongest Dock Gate yet. See page 17.

Back of Rack



Back of Rack stops product from being pushed off the rack. See page 12.

Roofguard



Roofguard See page 13.

Pivot Gate



Pivot Gate creates ideal mezzanine protection while allowing for easy pallet loading and unloading. See Page 23.



Double corner post

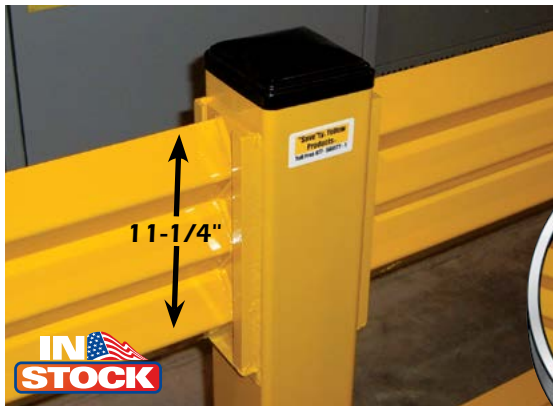

Inline post



Optional offset end post

Ribbed Rail "Stand Guard"

Our most popular item: the **Stand Guard** ribbed rail. "The Original **LIFT-OUT** Sleeve Design" reduces installation cost by half!

- Sleeves are welded to posts, **no costly brackets as an afterthought.**
- 4" posts with 10" x 10" x 1/2" base rated for impacts up to 10,000 lbs at 5 mph.
- 5" posts with 10" x 10" x 5/8" base rated for impacts up to 12,000 lbs at 5 mph.
- Painted steel caps are included with posts.
- Post heights: 18", 26" & 42".
- 10-gage, high-tensile steel rails fit either post.
- Rails are 2' through 10' in 1' increments.



FULLY WELDED SLEEVES!



Offset posts are in stock.

Guard Rails



Lite ribbed guard rail



Create a pedestrian walkway with Stand Guard Lite

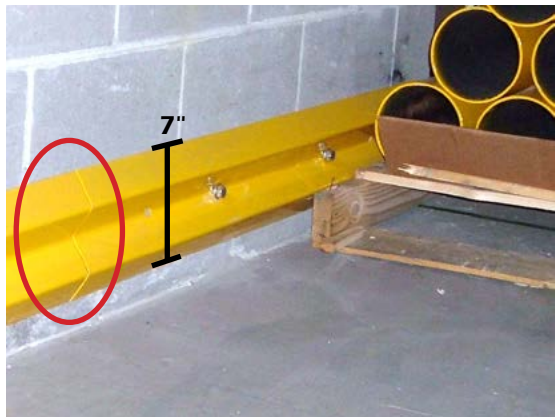

Quick Release LIFT-OUT design

Lite Duty Guard Rail

"Stand Guard" Lite is designed for powered and manual stackers, electric pallet trucks, steel carts & hoppers, etc.

- A great alternative to high strength guard rail, with *The Original LIFT-OUT Sleeve Design*.
- Designed for heavy impacts up to 5,000 lbs. at 5 mph.
- 4" posts, 18" & 42" high, with 8" x 8" x 1/2" base.
- 14-gage, high-tensile steel rails are 2' through 10' in 1' increments.



Wall Bumper Rail

Durable Steel Protection

- Mounts directly to wall on 16" centers
- 14 gage steel
- 2', 4', 6', and 10' lengths available
- Eliminate posts along perimeter walls
- Can be overlapped to reduce cutting in the field

Twin Rail

Durable steel protection

- Our original Twin Rail design from 2003 re-styled with stronger rails. It comes standard with **LIFT-OUT** rails that offer holes for bolting together if desired.
- Create a mezzanine gate with twin rail, utilizing the Quick Release LIFT-OUT design.
- 44" tall posts with a powder coated steel cap.
- 3" x 3" posts, with a 6" x 6" x 1/2" base plate is rated for 4000 lbs. impact at 4 mph.
- 4" tall x 2" wide rail is 11-gage high-tensile steel.
- Top rail is 42" high
- **MEETS OSHA REQUIREMENTS.**
- Available in 4', 6', 8' and 10' lengths.



Slim & short models



Eagle™ – Velcro™ strap



The Original **LIFT-OUT** Sleeve Design is available in single-rail height



Building and Mezzanine Column Protectors

Prevent damage to building support columns or mezzanine columns. From Eagle™ Mfg.

- **SHORT** Model is 24" tall x 24" wide for 6", 8", 10" & 12" columns, Yellow or Red.
- **SLIM** Model is 42" tall x 12" wide for 4", 5", & 6" columns, Yellow.
- **STANDARD** Model is 42" tall x 24" wide for 6", 8", 9" Round, 10", & 12" columns. Yellow standard, Lime Green or Orange with reflective tape also available.
- **FASTENERS** Velcro straps.
- **SHIPPING POINTS** Five shipping warehouses.
- Impact Rating – 8000 lbs @ 5 M.P.H."



Style	Eagle™	Colors
SHORT	6", 8", 10", 12"	Yellow, Red
SLIM	4" - 6"	Yellow
STANDARD	6", 8", 9" Round, 10", 12"	Yellow, Orange, Lime Green
FASTENER	Velcro Strap	Black

Protect Your Building Columns & Downspouts with Stand Guard Rail

Our most popular item: the **Stand Guard ribbed rail**. All welded **DROP-IN, LIFT-OUT** design standard.

- Sleeves are welded to posts, **no costly brackets as an afterthought**.
- Post heights: 18", 26" & 42"
- Rails are 2' through 10' in 1' increments.



Column Protectors

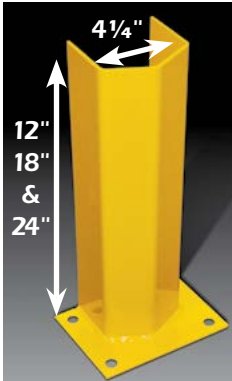

"V" face

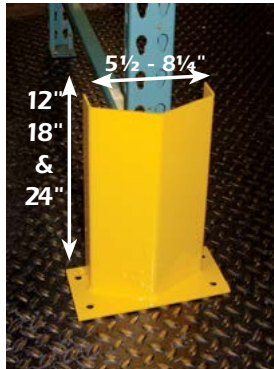

Seismic

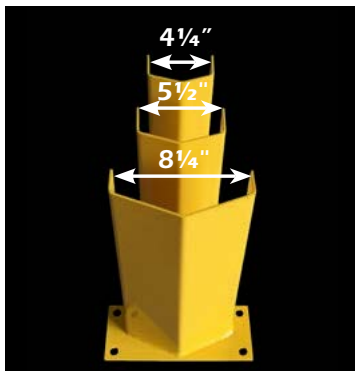

3 different heights & widths



Poly post protector



Corner Protector

**14,000
In Stock!**

Traditional Post Protectors

Traditional style post protection available in a "V" shape or formed face.

- Traditional style with four mounting holes.
- Choose from 12", 18", & 24" tall.
- Clear opening: 4 1/4".
- Anchors available upon request.

Seismic Post Protectors

Seismic post protectors in "V" face style designed to fit around seismic footplates.

- Clear opening of 5 1/2" or 8 1/4".
- Choose from 12", 18" or 24" tall.
- Base plate is 5" deep with four mounting holes.
- Anchors available upon request.

Poly Post Protectors

Easy snap on installation.

- Fits 3" x 1 5/8" or 3" x 3" rack.
- 8" tall x 5 1/2" O.D. wide.
- Stackable.

Corner Protector

- Protect corners.
- 4" x 4" x 18" tall.
- 4 mounting holes.
- Accepts 1/2" anchors.





Bolt On

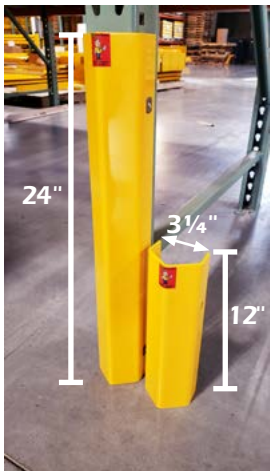

Side mount



Closed top for food industry



Flush hardware



Bolt On Post Protectors

Bolt-on post protectors add strength to frame column to prevent costly rack damage.

- Available in 18" tall with a clear opening 3 1/8".
- 3/16" thick wall.
- Optional hardware to attach to rack frame.
- Add strength to your upright.
- Mounting hole inside 1/4" thick bull nose.
- Accepts 5/8" anchor (additional).



Side Mount Frame / Column Protectors

Stop damage at every level.

- Increase frame strength.
- No base plate to interfere when storing pallets.
- 3 1/4" clear opening.
- 12" and 24" tall with 2" hole spacing.
- Mounting hardware included.

Food Industry Closed Top Post Protectors

New food industry closed Top Post/Column Protector

- 24" tall with closed top.
- Side mount with open/notched back for first beam level.
- 3 1/4" clear opening.
- 24" tall with 2" hole spacing.
- Mounting hardware included.



Post Protectors



Outrigger post protector

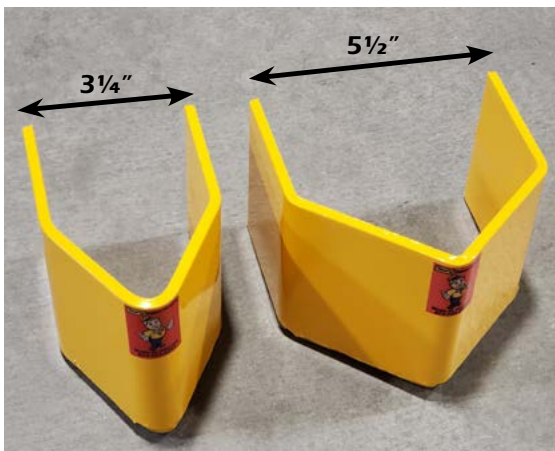

1/4" or 3/8" in stock



Post Protector No Base

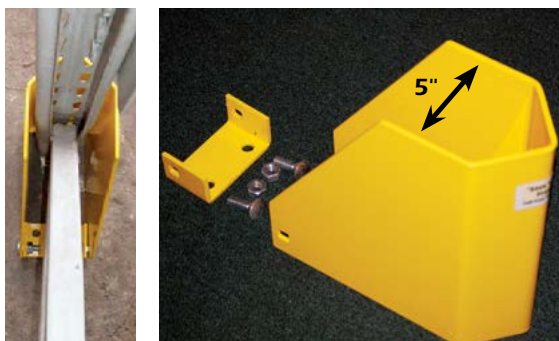

Patented

Outrigger Post Protectors

Designed specifically for Outriggers.

- Choose from 1/4" or 3/8" thickness.
- 4" tall x 3.25" clear, or 5.5" available.
- One mounting hole behind face.
- Accepts 5/8" anchors.



Post Protector No Base

- Formed from one plate of steel.
- Fits 4 1/4" or 5 1/2" clear opening.
- 3/4" clearance at the bottom.
- Accepts 1/2" anchors.



Hidden Anchor Post Protectors

Rack column post protectors eliminate base plates.

- Bolt down model with bracket hardware.
- Energy absorbing design anchors securely in front & behind frame.
- 12" tall by 9" deep.
- Inside dimensions are 5" x 5".
- TAPCON anchors available upon request.

End of Aisle Guards



Seismic option



Half curved end
(right hand pictured)



Double E.O.A.

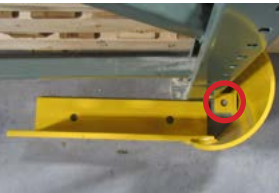

Three
mounting holes



Strong
corner protection



Rack Guard Round
Protects your warehouse



End of Aisle Rack Protection Curved End

Rack protection creates a visible guide through aisles and saves thousands in damage.

- Available in 36", 42" & 48", single or double ends.
- Custom sizes available.
- Curved end has an 8" I.D. x 12" tall.
- Choose floor angle thicknesses of 1/2", 3/8", and 1/4".

Super Duty Rack Guard

Three mounting holes.

- Our strongest rack guard yet with an extra mounting hole behind the curved face.
- 18" long with 6" x 4" x 1/2" steel angle.
- Has two mounting holes on the angle and one behind the nose.

Rack Guard Round

Solid welded construction.



- Fits snug to frame.
- Three 1/2" thick feet create an overall height of 5".
- Accommodates seismic foot plates up to 8" deep.
- 36", 42" or 48" O.A.L., with closed ends.
- Custom sizes available.

Pallet Stop

Prevent wall and product damage.

- 18" long x 5" tall, centered between rack frame, protects two skids at the same time.
- Anchors to the floor with two legs on either side of frame.
- Mounting feet may be mounted against the wall / Plastic end caps optional.



Rack Deflect and Pallet Guide



Reinforces rack and protects from impact



Flush hardware



Use as a pallet guide, reduces rack damage



Pallet guide or rack reinforcement

Rack Deflect

Prevents potential damage to crossbars by creating a barrier between the crossbars and forklifts.

- 4" tall x ¼" thick steel bars
- Steel bars can be stacked to create ½" thickness for additional strength.
- Available in 42" and 48"
- Mounted flush using double-end stud and weld nut so that nothing 'catches' on the hardware (see image below).
- Easy installation.
- Multiple bars can be used as bracing for the rack, providing reinforcement to the rack.



Pallet Guide

Prevents potential damage to crossbars and rack corners from pallets by creating a guide for pallets.

- 4" tall x ¼" thick steel bars.
- Available in 42" and 48"
- Mounted flush using double-end stud and weld nut so that nothing 'catches' on the hardware (see image below).
- Multiple bars can be used as bracing for the rack, providing reinforcement to the rack.
- Hardware included.

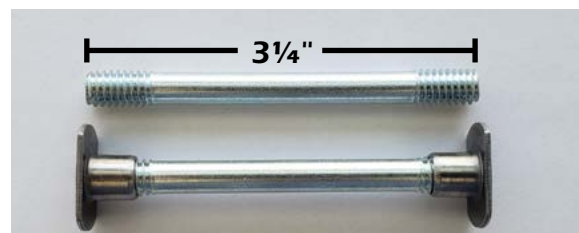

Flush mount hardware

Rack Protection



Front tab removes pressure from hardware

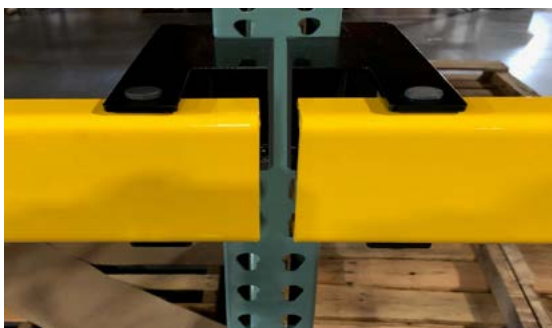
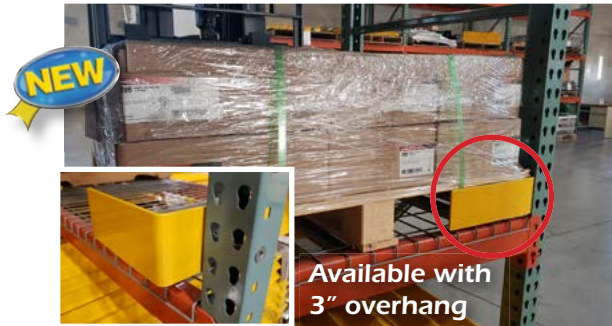

Pallet Guide / Stop

- Two products in one! – Keeps flue space clear and prevents damage to walls behind rack.
- 4" tall x ¼ thick steel bar with 10" return
- Available in 42", 45" (42" with 3" overhang), 48", and 51" (48" with 3" overhang).
- Mounts flush to double-end stud and weld nuts so that nothing "catches" on the hardware – see bottom of page 11 for hardware.
- Easy installation – hardware included.
- Creates additional reinforcement for the rack.
- Available without rear stop – see page 11.



Back of Rack

Designed to stop employees from pushing a skid off the back of the rack.

- High tensile steel brackets are 10 gage and are bolted to frames.
- Strong horizontal braces are secured in place with a ½" thick pin.
- Cut installation costs in half because there is no need for heavy netting, or the extreme hassle of netting installations.
- Low maintenance compared to broken straps, broken mesh panels and torn netting.
- Bracket measures 6" off the frame.
- This 10 gage thick brace is 4" tall, 97½" in length and is formed into a "C" channel for strength. See side profile above.
- ½" bracket hardware included.
- Use multiple braces for loose carton areas.
- Stocked in 8' sections, covering two pallet positions.
- Can be used in a back-to-back rack design to protect product from damage.



Perimeter Protection

Rooftop Perimeter Protection (Roofguard)

Roofguard is a versatile, rooftop fall protection system

- Free-standing, non-penetrating system with lightweight base plates.
- Can be used in both permanent and portable applications.
- Fast and easy installation – no drilling or special fasteners required.
- Available in 6', 8', and 10' handrail sections.
- **MEETS OSHA REQUIREMENTS.**
- Wind load tested.
- Can also be used on metal roof systems.



Interior Perimeter Protection

Perimeter protection products can save you thousands from lift trucks bumping into walls, door tracks, water and electrical pipes. Protect your facility today for much less than the cost of damage.



Fabric Savety Gate

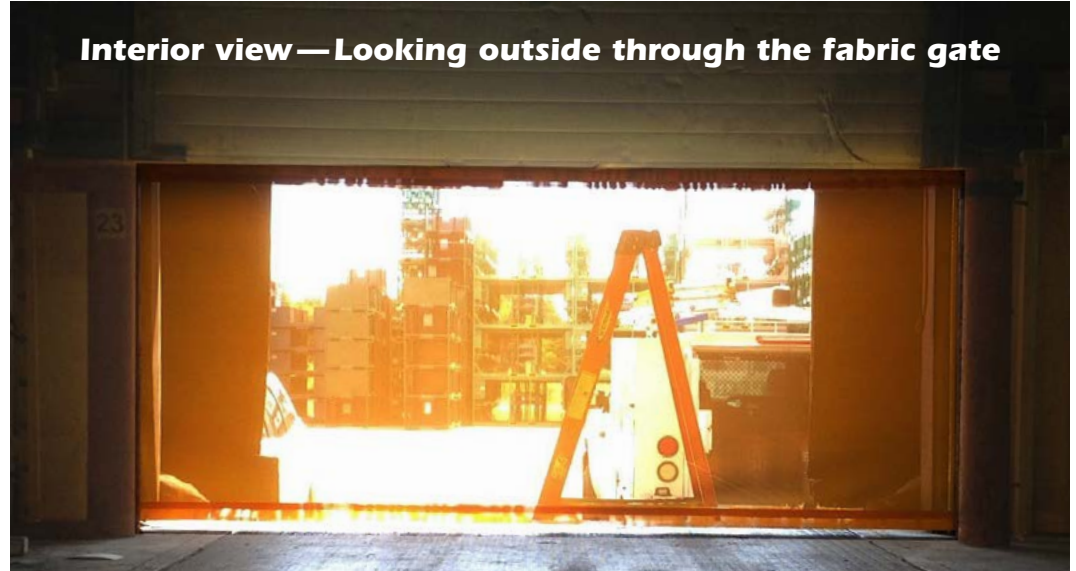

Our Fabric Savety Gate is perfect for dock doors that are often open. The Fabric Gate protects against unwanted visitors, insects, birds, and debris from entering the work area while allowing air to flow through. Our design allows for easy operation, requiring just 3 lbs of pull force to extend the gate. A locking feature prevents unwanted entry and theft.

- Accommodates doors from 8' – 16'
- High visibility
- Breathable fabric lets air circulate
- Small gap at base of the gate
- Easily retracts, requiring only 3 lbs of pull force



- Ratchet mechanism controls tension
- Locking feature included to prevent unwanted entry
- 48" tall
- **MEETS OSHA REQUIREMENTS.**
- Impact rating — 1000 lbs @ 4 M.P.H.

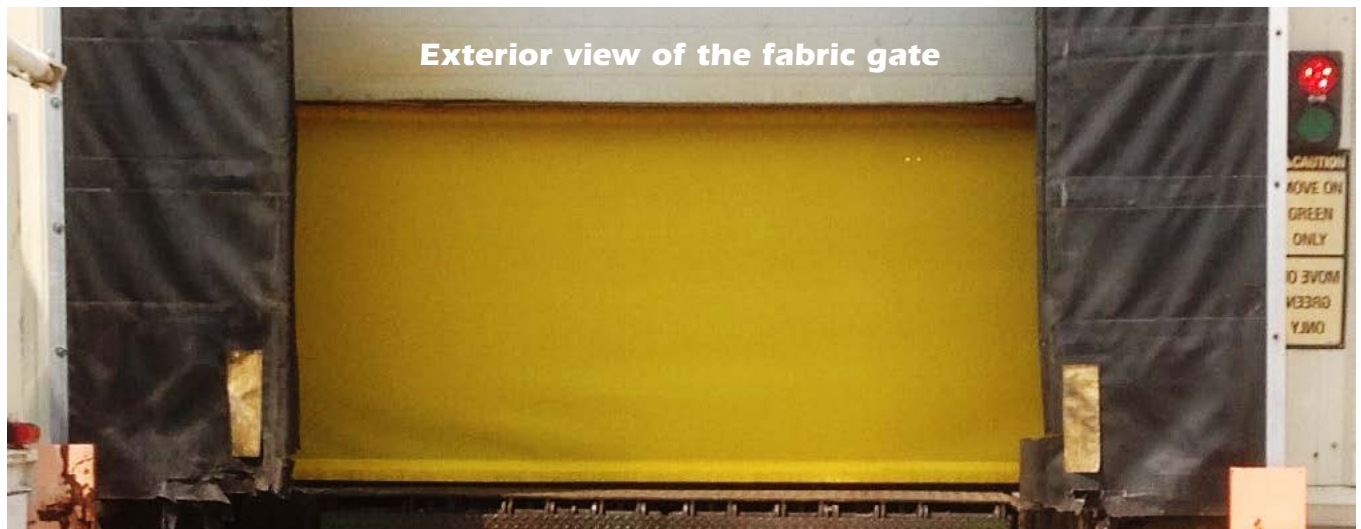

Dock Gates



Rotating gates: widths from 4' to 14'



Open dock



Locking Caster

Interior View



Exterior View

Rotating Dock Gate

Provides security, creates awareness and fall protection.

- Mounts over a 42" tall bollard which is required.
- Choose widths from 4' to 14'.
- Install two gates to meet in the center to accommodate space restrictions if needed.
- Add an optional bollard with eyelet at the opposite end for security.



Rolling Dock Safety Gate

Permits safe access in and out of the loading dock area with easy access and no lift and pinch hazards.

- Available in 8', 10', and 12' sizes.
- Durable 1.66" O.D. steel.
- Powder coated safety yellow.
- **MEETS OSHA REQUIREMENTS.**
- Rolling design eliminates lifting and pinch hazards.
- Mounting hardware optional.
- Locking caster stops drift.
- Easy installation – anchor base in minutes and you're done.



Dock Stop Lite



Patent Pending



Slide Bar Handle and Locking Pin

CREATE A REAL BARRIER

- Stop fork trucks from driving or backing off the dock
- Dock Stop includes two rotating arms
- Includes two 42" bollards with 10" x 10" x 1/2" base plates
- Locking slide bars with locking pin
- Impact rated for 4000 lbs at 4 mph
- 8', 9', 10', 11' and 12' door sizes in stock
- Built in height-levelers, so arms meet in the middle every time
- Powder coated safety yellow
- Include reflective 'Stop' signs



Dock Stop Heavy Duty

OUR STRONGEST DOCK GATE EVER! DOCK STOP *HD*

- Oversized 12" x 12" x 5/8" base plates with gussets for strength
- No pinch points when gate is closing
- 5" steel posts powder coated steel caps
- Robust 1" pins support gate arms
- Adjustable wrap around plate bolts to post to support gate arms
- Reinforced cross bar for strength behind panels
- 42" tall
- **MEETS OSHA REQUIREMENTS.**
- Impact rating — 10,000 lbs. @ 5 M.P.H.



Patent Pending

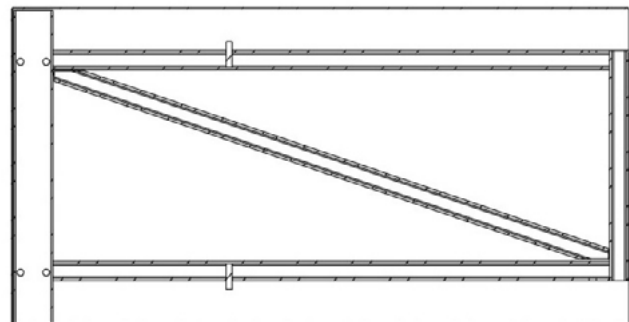

Reinforced Cross Bar



Lightweight Aluminum Arm

Dock Door Gates

Ideal for overhead doors. Great visibility to prevent accidents.

The "Save"ty Yellow Dock Gate is fabricated and bolts to post creating visibility. It is an economical and simple solution to comply with OSHA fall protection.

- Available in an 8', 10' and 12' clear opening.
- All sizes in stock.
- 42" tall at top of rail.
- New locking-pin design prevents gate from dropping.
- Air actuation cylinder holds gate open during deliveries or shipments.

Lift Gates: 8', 10' & 12' clear opening

▪ **MEETS OSHA REQUIREMENTS.**

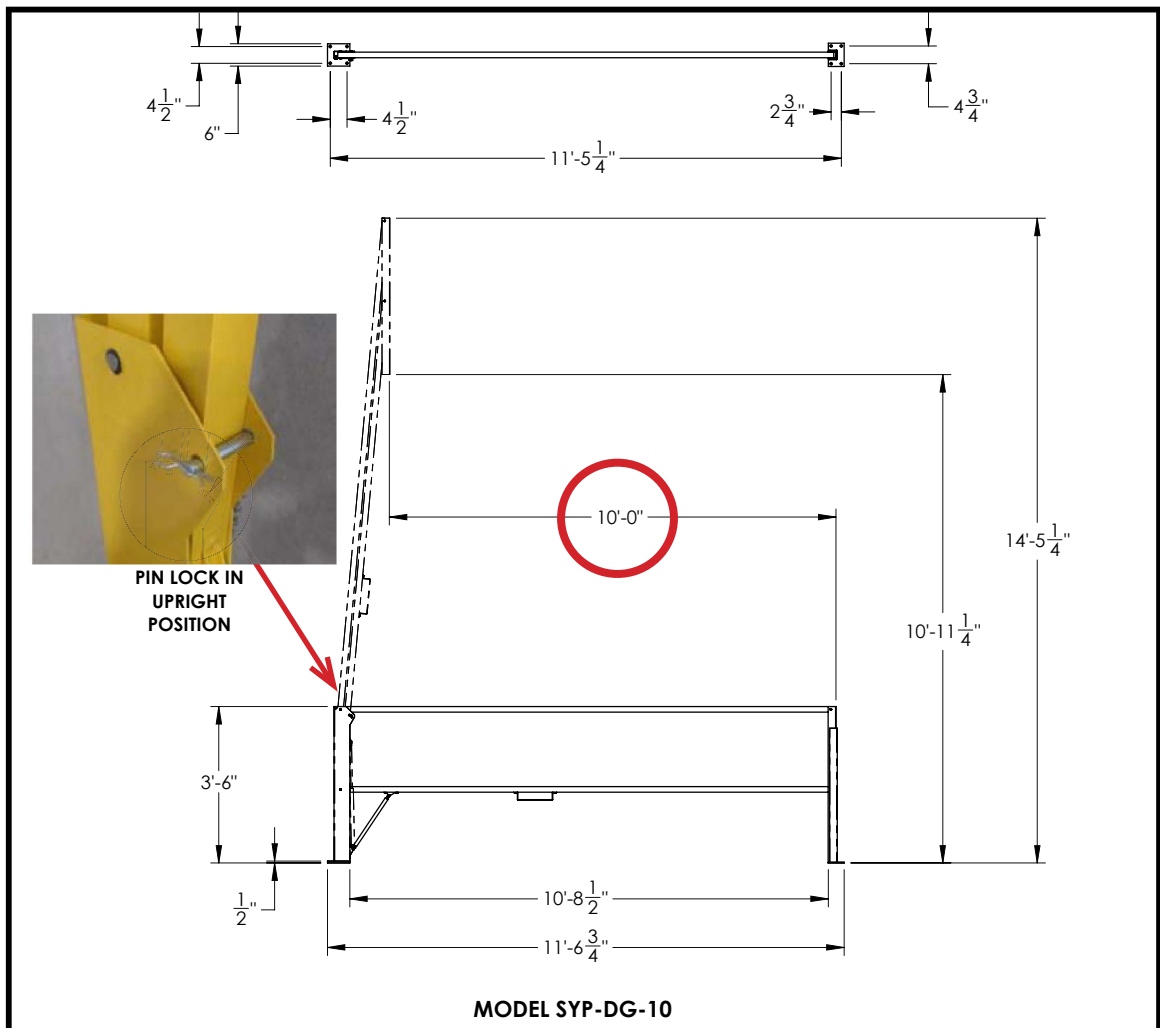

Hand Rails and Door Track



Indoor



Outdoor

Hand Rails

Modular hand rail protects employees from entering areas that are unsafe.

- Rails are powder coated yellow for long lasting durability.
- Easy installation, simply assemble and anchor down.
- Easy replacement of damaged sections or relocation.
- Stocked sizes: 4', 6', and 8' sections; can be cut down in the field.
- 1.66" O.D.
- **MEETS OSHA REQUIREMENTS.**
- 42" tall standard, ADA available.
- Fittings for mezzanine installation available.
- 1/8" kick plate (4" x 2") – In Stock.

Galvanized cast iron fittings

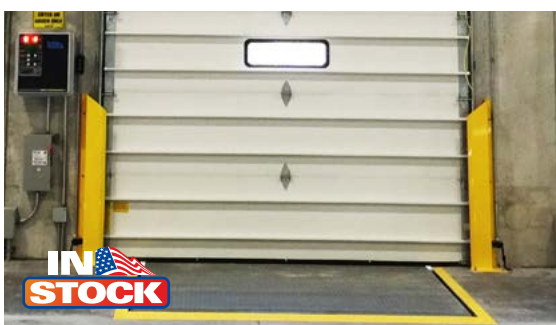

Door Track Protectors

Door Track protects overhead door track from damage while placing or retrieving pallets.

- Available with or without safety bevel.
- Eliminates expensive service calls for door repair.
- Available without baseplate.
- Standard duty for fork truck and commercial applications.
- Full 7" depth, up to 14" available.
- 36" and 48" tall in stock.
- 3/16" material, 1/4" base
- 1/4" available

Bollards



Stand Guard square bollards



White Reflective Band Available



Direct bury bollards

Steel Bollards

Steel bollards protect a variety of facility assets.

- Surface mount to concrete or Direct Bury.
- **Economy** 4.5" O.D., Yellow or Red, 5.5" O.D., Yellow only, 24," 36" or 42" tall.
- **Standard** 4.5" O.D. 42" tall, Yellow with black plastic cap; or 6.5" O.D. 24", 36" or 42" tall, Yellow with welded top, available with welded eyelet.
- **Direct Bury** 5.5", 6.5" & 8.5" O.D. 84" tall, Yellow.
- **Square Bollard** 4" square tube. 42" tall with painted steel cap.
- White reflective band available on any size bollard.

SAFETY PRODUCTS
LEAD FREE PAINT
MADE IN U.S.A.



We Have Your Bollards! Ready To Ship!

FAST DELIVERY

SURFACE MOUNT				
OD	HEIGHT	BASE	COLOR	TOP
4.5"	24", 36", 42"	8x8x¼	Yellow	Plastic cap
5.5"	24", 36", 42"	8x8x¼	Yellow	Plastic cap
6.5"	24", 36", 42"	9x9x½	Yellow	Welded
IN GROUND BOLLARDS				
OD	HEIGHT	BASE	COLOR	TOP
5.5"	84"	NONE	Yellow	OPEN
6.5"	84"	NONE	Yellow	OPEN
8.5"	84"	NONE	Yellow	OPEN

POWDER COATED TOUGH™



Safety Swing Gates



Great for stair openings



Double gate has built-in stop



Gate rotates 90° to open and stays upright until closed



Safety Swing Gates

Ideal for stair openings, ladders and platforms. The "Save"ty Swing Gate bolts to existing rail opening to provide a one-way, self-closing gate. It is a simple and economical solution to comply with OSHA.

Single & Double Gate

- Each gate has 2½" adjustability.
- Double Gate has built in stop.
- Single Gate requires a post for strike plate.
- Designed to fit hand railings.
- **MEETS OSHA REQUIREMENTS.**

Swing Gate No.	Fits Clear Opening	Wing Gate Part #	Fits Clear Opening
SINGLE GATE		DOUBLE GATE	
SYP-PS-15	14" - 17.5"	SYP-PS-9D	16" - 22.5"
SYP-PS-18	17" - 20.5"	SYP-PS-12D	22" - 28.5"
SYP-PS-21	20" - 23.5"	SYP-PS-15D	28" - 34.5"
SYP-PS-24	23" - 26.5"	SYP-PS-18D	34" - 40.5"
SYP-PS-27	26" - 29.5"	SYP-PS-21D	40" - 46.5"
SYP-PS-30	29" - 32.5"	SYP-PS-24D	46" - 52.5"
SYP-PS-33	32" - 35.5"	TELESCOPING GATE	
SYP-PS-36	35" - 38.5"	SYP-TEL	18" - 36"
SYP-PS-40	39" - 42.5"	NEW	
SYP-PS-44	43" - 46.5"		
SYP-PS-48	47" - 50.5"		

Lift A Gate

- Bolt to any standard guardrail, regardless of brand.
- Available in 36", 42", and 48"
- Self-closing option coming soon!
- Manual lift, manual close standard.
- Mounting instructions include a template for drilling through post.
- Cylinder rated for 10,000 cycles.
- Handrail kit coming soon!

Telescoping Swing Gate

- Adjusts to fit opens from 18" to 36".
- Can be installed on guardrail or handrail (2" O.D. max), regardless of brand.
- Can be inverted to swing either left or right.
- Springs designed for over 1 million cycles.
- Self closing.
- **MEETS OSHA REQUIREMENTS.**



PickerPal gate



Great 360 degree mezzanine protection



Bumper style

Mezzanine Safety Gates

We have five different styles of Mezzanine gates available to meet your needs — all are designed with fall protection per OSHA guidelines!

PickerPal Mezzanine Gates

- 6 self closing arms, operate independently.
- 6' or 8' width.
- Includes 8' tall rack frames and height limiter.
- **MEETS OSHA & IBC REQUIREMENTS.**

SafetyMezz360

For mezzanines or pick modules.

- Comes with 60" or 100" clear opening.
- Includes 4" safety toeboard.
- **COMPLIES WITH OSHA AND ANSI STANDARDS.**
- Utilizes a counter-balanced gate system and includes a slam-proof design.
- Easy to install and allows for one-handed operation.

Pallet Gate with Bumpers

- Standard Sizes: 60" or 72" clear opening width and clear opening height up to 84", includes gate columns, three (3) springs per gate, housed within hinge pivot.
- Teardrop Impact Bumpers: High-impact, ABS bumpers with 3" projection. Black.
- Specifications: High-impact, ABS adjustable 4" toe boards.
- **MEETS OSHA REQUIREMENTS.**

Mezzanine Gates



Horizontal sliding gate



Vertical lift gate

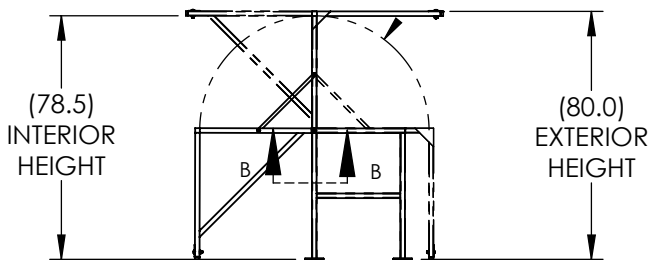

Adjustable kickplate
& rubber feet

Pivot gate – closed

Mezzanine Gates

The Horizontal Sliding Gate and the Vertical Lift Gate are designed to be durable, productive, provide the same protection as your railing systems, and meet federal OSHA requirements for standard railings.

- Easily slides open and closed.
- Manufactured to specific width requirements.
- Factory welded steel framework.
- Gates are 42" high, with one mid-rail and 4" toeboard.
- Electric or pneumatic operation available with remote control. Call for details.
- Easy Installation.
- **MEETS OSHA REQUIREMENTS.**



Pivot Gate

Single or Double width gates.

- Choose from 60", 65", 72" 96" or 120" clear opening.
- All welded tubular steel frame.
- Easily pivots to up or down position.
- Requires only 10-20 lbs. of lift force.
- Made to order to fit your specific opening.
- Ships mostly assembled – minor assembly required upon receiving and simply anchor to mezzanine floor.
- Adjustable kickplate and rubber feet.
- **MEETS OSHA REQUIREMENTS.**



Flat Top



Dome Top

Blue Light

Increase warehouse safety by adding a Blue Light to increase visibility and awareness of fork trucks.

- Mount to fork truck (front or rear).
- Hardware and 12" wire lead provided.
- 5 bright LED lights create 400 Lumens of bright blue light in the path of the fork truck (subject to change).

Fork Extension Bracket

Stop looking for a place to put your fork extensions!

- Holds up to 3 fork blade extensions.
- Can be wall or rack mounted, hardware not included.
- Solid high tensile steel construction for long-lasting durability.
- Measures 6" wide x 8" tall, hook extends out 5".
- Powder coated Savety Yellow.

Bollard Sleeves

- Made using a 1/8" thick High Density Polyethylene plastic, the sleeves are designed to absorb impact, be solvent resistant, resist fading in ultraviolet light, and can withstand extreme temperatures.
- On the Flat Top sleeves, 3M reflective stripes increase visibility.
- Mounting kit included at no charge.
- Dropship direct to your customer.
- Available in 4½" – 12¾" diameter.
- Sleeves can be cut to size at no charge.
- Choose from Flat Top or Dome Top sleeves.
- Sleeves slide on quickly and easily, no hassle.

Flat Top		Dome Top	
I.D.	Height	I.D.	Height
4.5"	52"	4.5"	52"
4.5"	64"	4.5"	64"
7"	52"	7"	52"
7"	60"	7"	60"
7"	72"	7"	72"
8-7/8"	72"		
8-7/8"	60"		
11-1/3"	60"		



Our Products at Work

Application Photo Gallery

Applications are indispensable when you consider the value of assets that need protection.

Our products secure many areas and stand guard to protect the facilities and employees of small, medium and large corporations.

If you have an application that you would like to discuss, we will help you find the best solution to fit your needs. We have the experience and resources to assure that you and your facility will remain protected.

At "SAVE"ty Yellow Products it's our mission to help SAVE YOUR ASSETS!



Guarding equipment



Door track guards



Guarding battery racks



Guarding electrical panels



Guarding refrigeration



Guarding employees behind drywall

"Save"ty[®] Yellow Products



Protect vulnerable access points

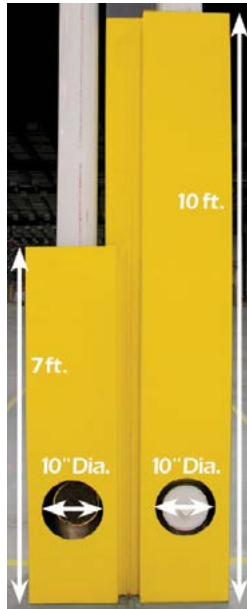

Custom made



Building Column & Downspout Guard Rail



See pages 4 and 21



See page 15

Our Products at Work



Perimeter protection and rack guard



Drive thru rack protection



Lift up and out of the way



Strong end of aisle rack protection with offset baseplates

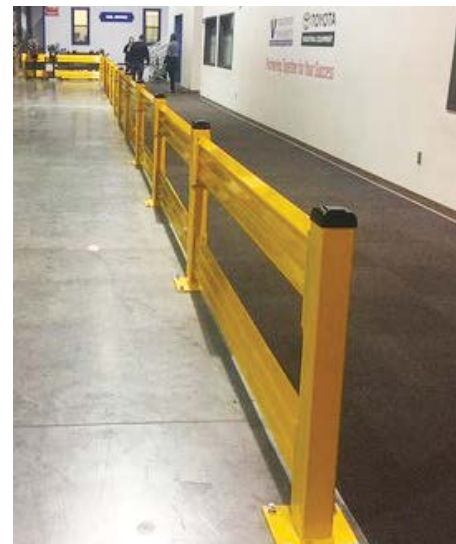

Create a safe passage



Yellow Products

FACILITY ASSET PROTECTION



**New Products:
Page 3**



Save Your Assets

- People
- Products
- Equipment
- More



IN STOCK

"Save'ty® Stand Guard Rails & Systems



Protecting The Supply Chain.



We Deliver MORE Than Just Our Products!

We Deliver PEACE OF MIND!

Without "Save"ty Yellow Products, you may be worrying more about safety issues than you should be.

You have invested in your business – equipment, inventory, and especially employees – to meet the needs of your customers. You don't want unexpected safety issues to cause you downtime, added expense, or personal injury. Let "Save"ty Yellow Products help protect your business and **SAVE YOUR ASSETS!**

Our products have been shown to protect employees, facilities, products, and equipment from impact with fork trucks, and do it better and at a lower cost! We have supplied products to facilities used by some of America's finest companies, including Amazon, U.S. Foods, Adidas, Home Depot, and General Electric.

Built on the foundation of "The Original **LIFT-OUT Sleeve Design**" guard rail system, "Save"ty Yellow Products has branched out to include facility protection, hand

rails, safety gates and more. We continue to develop new products to meet safety needs and also customize products for specific applications.

The products we manufacture are made in America, powder coated with certified lead-free paint, and stocked in Illinois.

We invite you to enjoy the peace of mind that comes from knowing that your business is protected 24/7. "Save"ty Yellow Products can help you do that!

– The Gentile Family

The little things matter...



In Stock



Quality



Packaging



New Additions

NEW FOR 2020

Rolling Gate

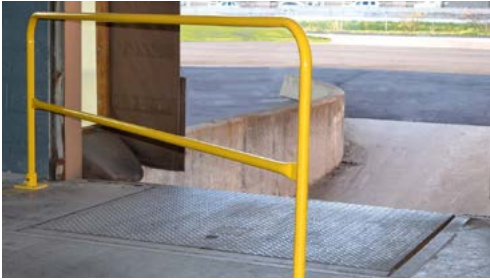

Economical **Rolling Gate** for customers on a budget. See page 13.

Fabric Gate

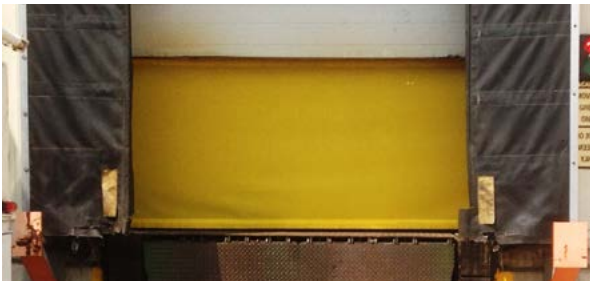

Retractable **Fabric Gate** for customers who want to let in a little air and have security at the same time. See page 14.

Rack Deflect

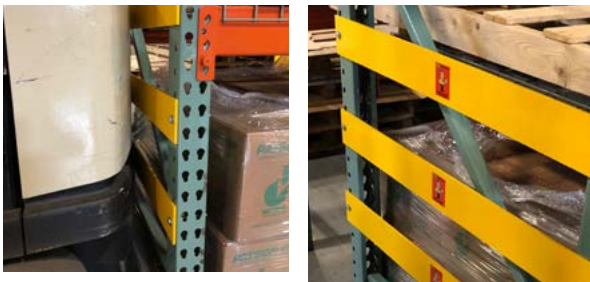

Rack Deflect was designed to block side frame damage. See page 11.

Pallet Guide



Pallet Guide steers pallets into place without hitting the rear of the frame. Also works as a frame brace. See page 11.

Dock Stop HD



Dock Stop HD, our strongest Dock Gate yet. See page 17.

Back of Rack



Back of Rack stops product from being pushed off the rack. See page 12.

Roofguard



Roofguard See page 13.

Pivot Gate



Pivot Gate creates ideal mezzanine protection while allowing for easy pallet loading and unloading. See Page 23.



Double corner post



Inline post



Optional offset end post

Ribbed Rail "Stand Guard"

Our most popular item: the **Stand Guard** ribbed rail. "The Original **LIFT-OUT** Sleeve Design" reduces installation cost by half!

- Sleeves are welded to posts, **no costly brackets as an afterthought.**
- 4" posts with 10" x 10" x 1/2" base rated for impacts up to 10,000 lbs at 5 mph.
- 5" posts with 10" x 10" x 5/8" base rated for impacts up to 12,000 lbs at 5 mph.
- Painted steel caps are included with posts.
- Post heights: 18", 26" & 42".
- 10-gage, high-tensile steel rails fit either post.
- Rails are 2' through 10' in 1' increments.



FULLY WELDED SLEEVES!

Offset posts are in stock.



Guard Rails



Lite ribbed guard rail



Create a pedestrian walkway with Stand Guard Lite

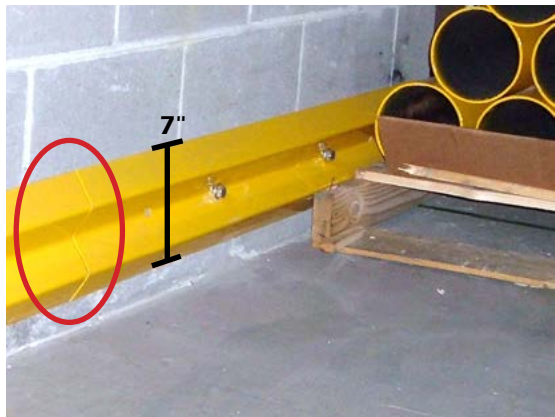

Quick Release LIFT-OUT design

Lite Duty Guard Rail

"Stand Guard" Lite is designed for powered and manual stackers, electric pallet trucks, steel carts & hoppers, etc.

- A great alternative to high strength guard rail, with *The Original LIFT-OUT Sleeve Design*.
- Designed for heavy impacts up to 5,000 lbs. at 5 mph.
- 4" posts, 18" & 42" high, with 8" x 8" x 1/2" base.
- 14-gage, high-tensile steel rails are 2' through 10' in 1' increments.



Wall Bumper Rail

Durable Steel Protection

- Mounts directly to wall on 16" centers
- 14 gage steel
- 2', 4', 6', and 10' lengths available
- Eliminate posts along perimeter walls
- Can be overlapped to reduce cutting in the field

Twin Rail

Durable steel protection

- Our original Twin Rail design from 2003 re-styled with stronger rails. It comes standard with **LIFT-OUT** rails that offer holes for bolting together if desired.
- Create a mezzanine gate with twin rail, utilizing the Quick Release LIFT-OUT design.
- 44" tall posts with a powder coated steel cap.
- 3" x 3" posts, with a 6" x 6" x 1/2" base plate is rated for 4000 lbs. impact at 4 mph.
- 4" tall x 2" wide rail is 11-gage high-tensile steel.
- Top rail is 42" high
- **MEETS OSHA REQUIREMENTS.**
- Available in 4', 6', 8' and 10' lengths.



Slim & short models



Eagle™ – Velcro™ strap



The Original **LIFT-OUT** Sleeve Design is available in single-rail height



Building and Mezzanine Column Protectors

Prevent damage to building support columns or mezzanine columns. From Eagle™ Mfg.

- **SHORT** Model is 24" tall x 24" wide for 6", 8", 10" & 12" columns, Yellow or Red.
- **SLIM** Model is 42" tall x 12" wide for 4", 5", & 6" columns, Yellow.
- **STANDARD** Model is 42" tall x 24" wide for 6", 8", 9" Round, 10", & 12" columns. Yellow standard, Lime Green or Orange with reflective tape also available.
- **FASTENERS** Velcro straps.
- **SHIPPING POINTS** Five shipping warehouses.
- Impact Rating – 8000 lbs @ 5 M.P.H."



Style	Eagle™	Colors
SHORT	6", 8", 10", 12"	Yellow, Red
SLIM	4" - 6"	Yellow
STANDARD	6", 8", 9" Round, 10", 12"	Yellow, Orange, Lime Green
FASTENER	Velcro Strap	Black

Protect Your Building Columns & Downspouts with Stand Guard Rail

Our most popular item: the **Stand Guard ribbed rail**. All welded **DROP-IN, LIFT-OUT** design standard.

- Sleeves are welded to posts, **no costly brackets as an afterthought**.
- Post heights: 18", 26" & 42"
- Rails are 2' through 10' in 1' increments.



Column Protectors

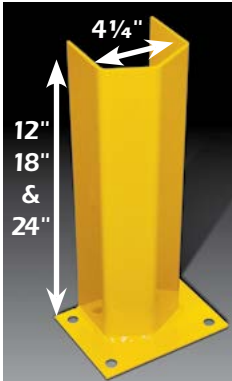

"V" face

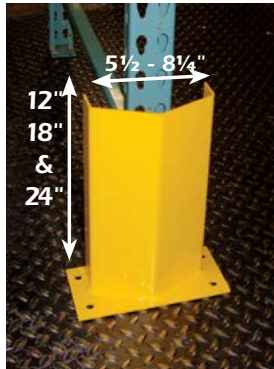

Seismic

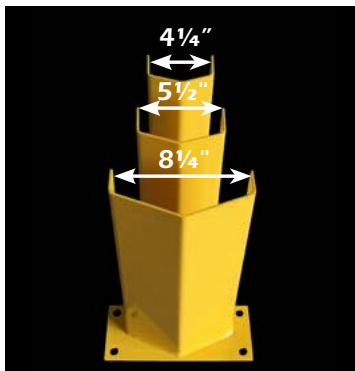

3 different heights & widths



Poly post protector



Corner Protector

**14,000
In Stock!**

Traditional Post Protectors

Traditional style post protection available in a "V" shape or formed face.

- Traditional style with four mounting holes.
- Choose from 12", 18", & 24" tall.
- Clear opening: 4 1/4".
- Anchors available upon request.

Seismic Post Protectors

Seismic post protectors in "V" face style designed to fit around seismic footplates.

- Clear opening of 5 1/2" or 8 1/4".
- Choose from 12", 18" or 24" tall.
- Base plate is 5" deep with four mounting holes.
- Anchors available upon request.

Poly Post Protectors

Easy snap on installation.

- Fits 3" x 1 5/8" or 3" x 3" rack.
- 8" tall x 5 1/2" O.D. wide.
- Stackable.

Corner Protector

- Protect corners.
- 4" x 4" x 18" tall.
- 4 mounting holes.
- Accepts 1/2" anchors.





Bolt On

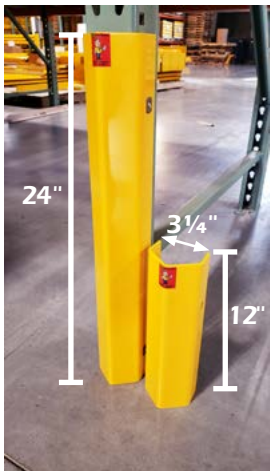

Side mount



Closed top for food industry



Flush hardware



Bolt On Post Protectors

Bolt-on post protectors add strength to frame column to prevent costly rack damage.

- Available in 18" tall with a clear opening 3 1/8".
- 3/16" thick wall.
- Optional hardware to attach to rack frame.
- Add strength to your upright.
- Mounting hole inside 1/4" thick bull nose.
- Accepts 5/8" anchor (additional).



Side Mount Frame / Column Protectors

Stop damage at every level.

- Increase frame strength.
- No base plate to interfere when storing pallets.
- 3 1/4" clear opening.
- 12" and 24" tall with 2" hole spacing.
- Mounting hardware included.

Food Industry Closed Top Post Protectors

New food industry closed Top Post/Column Protector

- 24" tall with closed top.
- Side mount with open/notched back for first beam level.
- 3 1/4" clear opening.
- 24" tall with 2" hole spacing.
- Mounting hardware included.



Post Protectors



Outrigger post protector

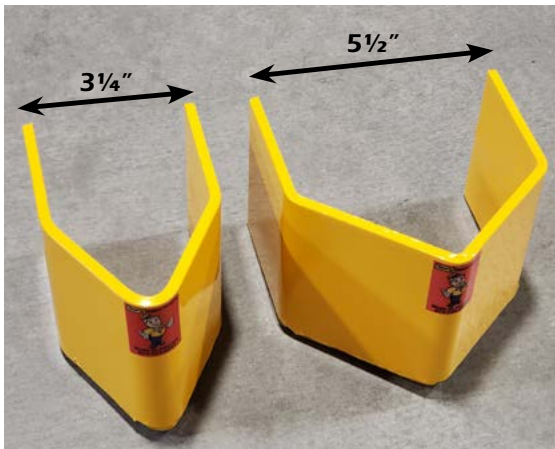

1/4" or 3/8" in stock



Post Protector No Base

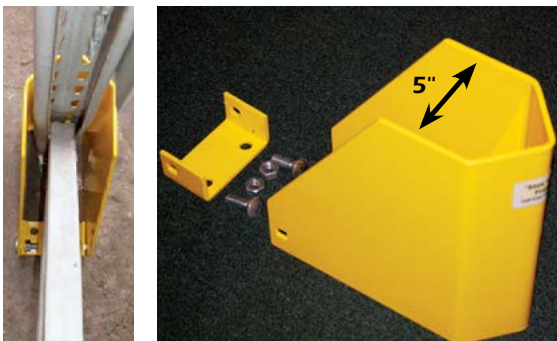

Patented

Outrigger Post Protectors

Designed specifically for Outriggers.

- Choose from 1/4" or 3/8" thickness.
- 4" tall x 3.25" clear, or 5.5" available.
- One mounting hole behind face.
- Accepts 5/8" anchors.



Post Protector No Base

- Formed from one plate of steel.
- Fits 4 1/4" or 5 1/2" clear opening.
- 3/4" clearance at the bottom.
- Accepts 1/2" anchors.



Hidden Anchor Post Protectors

Rack column post protectors eliminate base plates.

- Bolt down model with bracket hardware.
- Energy absorbing design anchors securely in front & behind frame.
- 12" tall by 9" deep.
- Inside dimensions are 5" x 5".
- TAPCON anchors available upon request.

End of Aisle Guards



Seismic option



Half curved end
(right hand pictured)



Double E.O.A.

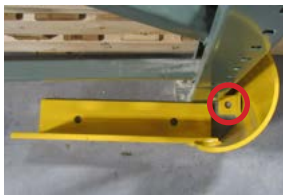

Three
mounting holes



Strong
corner protection



Rack Guard Round
Protects your warehouse



End of Aisle Rack Protection Curved End

Rack protection creates a visible guide through aisles and saves thousands in damage.

- Available in 36", 42" & 48", single or double ends.
- Custom sizes available.
- Curved end has an 8" I.D. x 12" tall.
- Choose floor angle thicknesses of $\frac{1}{2}$ ", $\frac{3}{8}$ ", and $\frac{1}{4}$ ".

Super Duty Rack Guard

Three mounting holes.

- Our strongest rack guard yet with an extra mounting hole behind the curved face.
- 18" long with 6" x 4" x $\frac{1}{2}$ " steel angle.
- Has two mounting holes on the angle and one behind the nose.

Rack Guard Round

Solid welded construction.



- Fits snug to frame.
- Three $\frac{1}{2}$ " thick feet create an overall height of 5".
- Accommodates seismic foot plates up to 8" deep.
- 36", 42" or 48" O.A.L., with closed ends.
- Custom sizes available.

Pallet Stop

Prevent wall and product damage.

- 18" long x 5" tall, centered between rack frame, protects two skids at the same time.
- Anchors to the floor with two legs on either side of frame.
- Mounting feet may be mounted against the wall / Plastic end caps optional.



Rack Deflect and Pallet Guide



Reinforces rack and protects from impact



Flush hardware



Use as a pallet guide, reduces rack damage

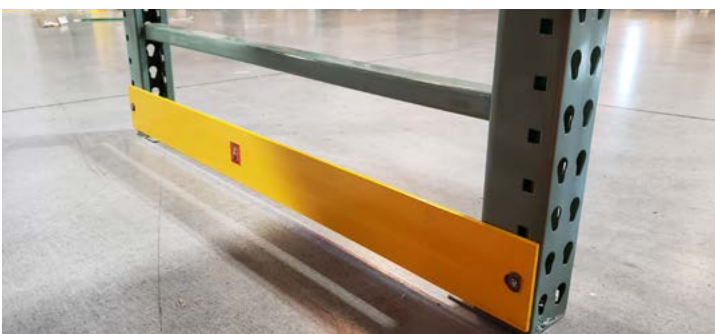

Pallet guide or rack reinforcement

Rack Deflect

Prevents potential damage to crossbars by creating a barrier between the crossbars and forklifts.

- 4" tall x ¼" thick steel bars
- Steel bars can be stacked to create ½" thickness for additional strength.
- Available in 42" and 48"
- Mounted flush using double-end stud and weld nut so that nothing 'catches' on the hardware (see image below).
- Easy installation.
- Multiple bars can be used as bracing for the rack, providing reinforcement to the rack.



Pallet Guide

Prevents potential damage to crossbars and rack corners from pallets by creating a guide for pallets.

- 4" tall x ¼" thick steel bars.
- Available in 42" and 48"
- Mounted flush using double-end stud and weld nut so that nothing 'catches' on the hardware (see image below).
- Multiple bars can be used as bracing for the rack, providing reinforcement to the rack.
- Hardware included.

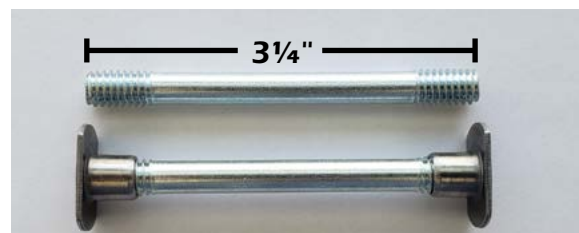

Flush mount hardware

Rack Protection



Front tab removes pressure from hardware

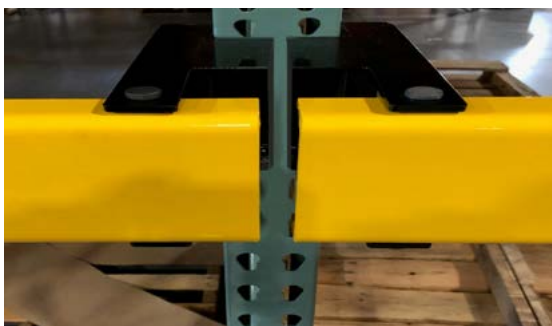
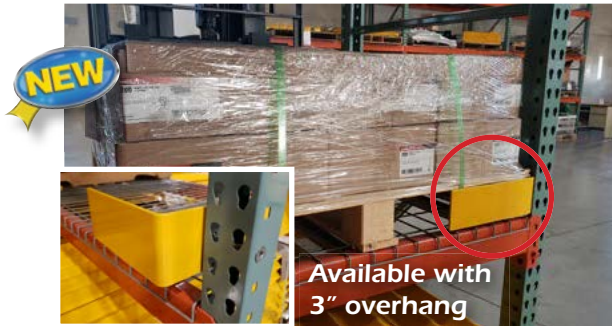

Pallet Guide / Stop

- Two products in one! – Keeps flue space clear and prevents damage to walls behind rack.
- 4" tall x ¼ thick steel bar with 10" return
- Available in 42", 45" (42" with 3" overhang), 48", and 51" (48" with 3" overhang).
- Mounts flush to double-end stud and weld nuts so that nothing "catches" on the hardware – see bottom of page 11 for hardware.
- Easy installation – hardware included.
- Creates additional reinforcement for the rack.
- Available without rear stop – see page 11.



Back of Rack

Designed to stop employees from pushing a skid off the back of the rack.

- High tensile steel brackets are 10 gage and are bolted to frames.
- Strong horizontal braces are secured in place with a ½" thick pin.
- Cut installation costs in half because there is no need for heavy netting, or the extreme hassle of netting installations.
- Low maintenance compared to broken straps, broken mesh panels and torn netting.
- Bracket measures 6" off the frame.
- This 10 gage thick brace is 4" tall, 97½" in length and is formed into a "C" channel for strength. See side profile above.
- ½" bracket hardware included.
- Use multiple braces for loose carton areas.
- Stocked in 8' sections, covering two pallet positions.
- Can be used in a back-to-back rack design to protect product from damage.



Perimeter Protection

Rooftop Perimeter Protection (Roofguard)

Roofguard is a versatile, rooftop fall protection system

- Free-standing, non-penetrating system with lightweight base plates.
- Can be used in both permanent and portable applications.
- Fast and easy installation – no drilling or special fasteners required.
- Available in 6', 8', and 10' handrail sections.
- **MEETS OSHA REQUIREMENTS.**
- Wind load tested.
- Can also be used on metal roof systems.



Interior Perimeter Protection

Perimeter protection products can save you thousands from lift trucks bumping into walls, door tracks, water and electrical pipes. Protect your facility today for much less than the cost of damage.



Fabric Savety Gate



Interior view—Looking outside through the fabric gate

Our Fabric Savety Gate is perfect for dock doors that are often open. The Fabric Gate protects against unwanted visitors, insects, birds, and debris from entering the work area while allowing air to flow through. Our design allows for easy operation, requiring just 3 lbs of pull force to extend the gate. A locking feature prevents unwanted entry and theft.

- Accommodates doors from 8' – 16'
- High visibility
- Breathable fabric lets air circulate
- Small gap at base of the gate
- Easily retracts, requiring only 3 lbs of pull force



- Ratchet mechanism controls tension
- Locking feature included to prevent unwanted entry
- 48" tall
- **MEETS OSHA REQUIREMENTS.**
- Impact rating — 1000 lbs @ 4 M.P.H.

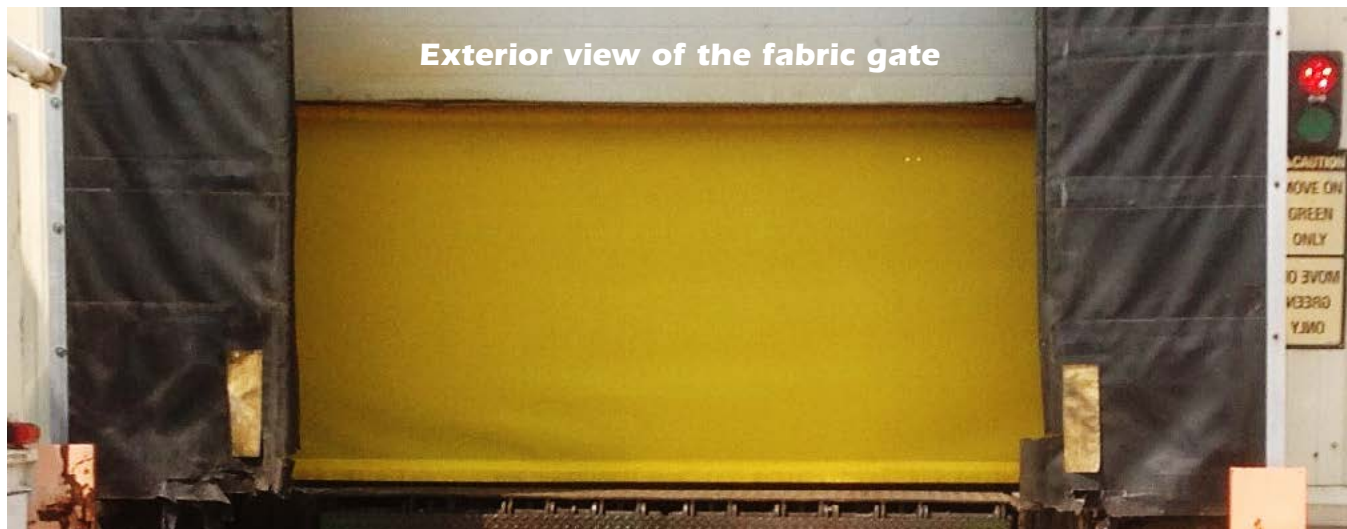

Exterior view of the fabric gate

Dock Gates



Rotating gates: widths from 4' to 14'



Open dock



Locking Caster

Interior View



Exterior View

Rotating Dock Gate

Provides security, creates awareness and fall protection.

- Mounts over a 42" tall bollard which is required.
- Choose widths from 4' to 14'.
- Install two gates to meet in the center to accommodate space restrictions if needed.
- Add an optional bollard with eyelet at the opposite end for security.



Rolling Dock Safety Gate

Permits safe access in and out of the loading dock area with easy access and no lift and pinch hazards.

- Available in 8', 10', and 12' sizes.
- Durable 1.66" O.D. steel.
- Powder coated safety yellow.
- **MEETS OSHA REQUIREMENTS.**
- Rolling design eliminates lifting and pinch hazards.
- Mounting hardware optional.
- Locking caster stops drift.
- Easy installation – anchor base in minutes and you're done.



Dock Stop Lite



Patent Pending



CREATE A REAL BARRIER

- Stop fork trucks from driving or backing off the dock
- Dock Stop includes two rotating arms
- Includes two 42" bollards with 10" x 10" x 1/2" base plates
- Locking slide bars with locking pin
- Impact rated for 4000 lbs at 4 mph
- 8', 9', 10', 11' and 12' door sizes in stock
- Built in height-levelers, so arms meet in the middle every time
- Powder coated safety yellow
- Include reflective 'Stop' signs



Slide Bar Handle and Locking Pin



Dock Stop Heavy Duty

OUR STRONGEST DOCK GATE EVER! DOCK STOP *HD*

- Oversized 12" x 12" x 5/8" base plates with gussets for strength
- No pinch points when gate is closing
- 5" steel posts powder coated steel caps
- Robust 1" pins support gate arms
- Adjustable wrap around plate bolts to post to support gate arms
- Reinforced cross bar for strength behind panels
- 42" tall
- **MEETS OSHA REQUIREMENTS.**
- Impact rating — 10,000 lbs. @ 5 M.P.H.



Patent Pending

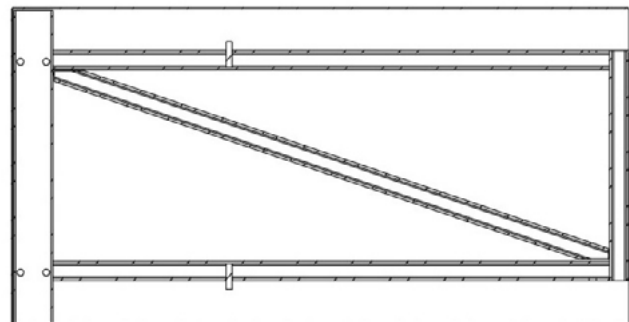

Reinforced Cross Bar



Lightweight Aluminum Arm

Dock Door Gates

Ideal for overhead doors. Great visibility to prevent accidents.

The "Save"ty Yellow Dock Gate is fabricated and bolts to post creating visibility. It is an economical and simple solution to comply with OSHA fall protection.

- Available in an 8', 10' and 12' clear opening.
- All sizes in stock.
- 42" tall at top of rail.
- New locking-pin design prevents gate from dropping.
- Air actuation cylinder holds gate open during deliveries or shipments.

Lift Gates: 8', 10' & 12' clear opening

▪ **MEETS OSHA REQUIREMENTS.**

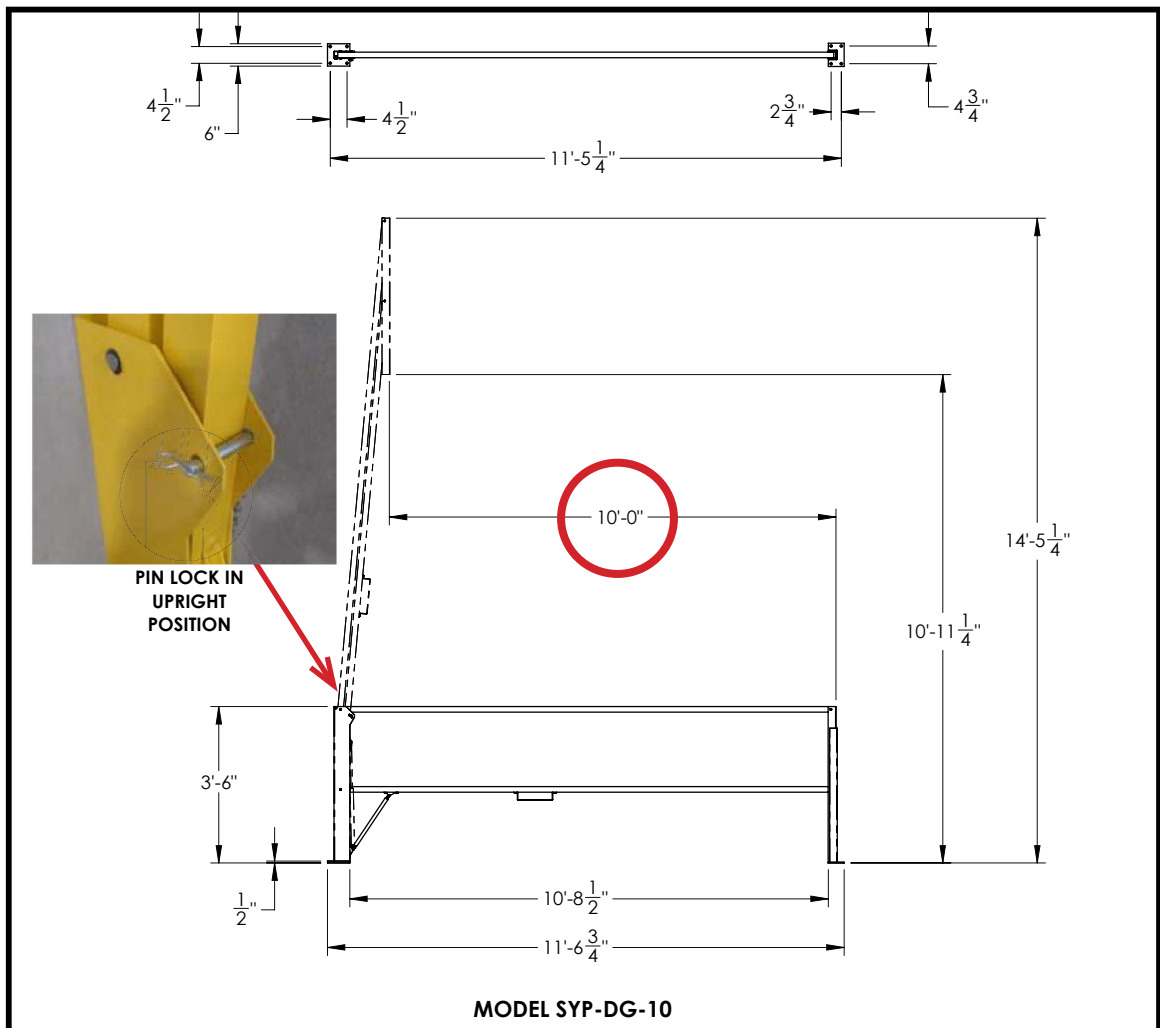

Hand Rails and Door Track



Indoor



Outdoor

Hand Rails

Modular hand rail protects employees from entering areas that are unsafe.

- Rails are powder coated yellow for long lasting durability.
- Easy installation, simply assemble and anchor down.
- Easy replacement of damaged sections or relocation.
- Stocked sizes: 4', 6', and 8' sections; can be cut down in the field.
- 1.66" O.D.
- **MEETS OSHA REQUIREMENTS.**
- 42" tall standard, ADA available.
- Fittings for mezzanine installation available.
- 1/8" kick plate (4" x 2") – In Stock.

Galvanized cast iron fittings

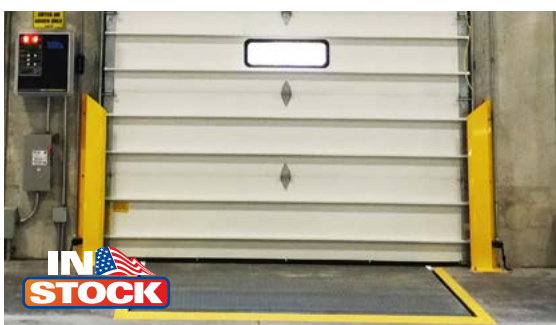

Door Track Protectors

Door Track protects overhead door track from damage while placing or retrieving pallets.

- Available with or without safety bevel.
- Eliminates expensive service calls for door repair.
- Available without baseplate.
- Standard duty for fork truck and commercial applications.
- Full 7" depth, up to 14" available.
- 36" and 48" tall in stock.
- 3/16" material, 1/4" base
- 1/4" available

Bollards



Stand Guard square bollards



White Reflective Band Available



Direct bury bollards

Steel Bollards

Steel bollards protect a variety of facility assets.

- Surface mount to concrete or Direct Bury.
- **Economy** 4.5" O.D., Yellow or Red, 5.5" O.D., Yellow only, 24," 36" or 42" tall.
- **Standard** 4.5" O.D. 42" tall, Yellow with black plastic cap; or 6.5" O.D. 24", 36" or 42" tall, Yellow with welded top, available with welded eyelet.
- **Direct Bury** 5.5", 6.5" & 8.5" O.D. 84" tall, Yellow.
- **Square Bollard** 4" square tube. 42" tall with painted steel cap.
- White reflective band available on any size bollard.



We Have Your Bollards! Ready To Ship!

FAST DELIVERY

SURFACE MOUNT				
OD	HEIGHT	BASE	COLOR	TOP
4.5"	24", 36", 42"	8x8x¼	Yellow	Plastic cap
5.5"	24", 36", 42"	8x8x¼	Yellow	Plastic cap
6.5"	24", 36", 42"	9x9x½	Yellow	Welded
IN GROUND BOLLARDS				
OD	HEIGHT	BASE	COLOR	TOP
5.5"	84"	NONE	Yellow	OPEN
6.5"	84"	NONE	Yellow	OPEN
8.5"	84"	NONE	Yellow	OPEN



Safety Swing Gates



Great for stair openings



Double gate has built-in stop



Gate rotates 90° to open and stays upright until closed



Safety Swing Gates

Ideal for stair openings, ladders and platforms. The "Save"ty Swing Gate bolts to existing rail opening to provide a one-way, self-closing gate. It is a simple and economical solution to comply with OSHA.

Single & Double Gate

- Each gate has 2½" adjustability.
- Double Gate has built in stop.
- Single Gate requires a post for strike plate.
- Designed to fit hand railings.
- **MEETS OSHA REQUIREMENTS.**

Swing Gate No.	Fits Clear Opening	Wing Gate Part #	Fits Clear Opening
SINGLE GATE		DOUBLE GATE	
SYP-PS-15	14" - 17.5"	SYP-PS-9D	16" - 22.5"
SYP-PS-18	17" - 20.5"	SYP-PS-12D	22" - 28.5"
SYP-PS-21	20" - 23.5"	SYP-PS-15D	28" - 34.5"
SYP-PS-24	23" - 26.5"	SYP-PS-18D	34" - 40.5"
SYP-PS-27	26" - 29.5"	SYP-PS-21D	40" - 46.5"
SYP-PS-30	29" - 32.5"	SYP-PS-24D	46" - 52.5"
SYP-PS-33	32" - 35.5"	TELESCOPING GATE	
SYP-PS-36	35" - 38.5"	SYP-TEL	18" - 36"
SYP-PS-40	39" - 42.5"	NEW	
SYP-PS-44	43" - 46.5"		
SYP-PS-48	47" - 50.5"		

Lift A Gate

- Bolt to any standard guardrail, regardless of brand.
- Available in 36", 42", and 48"
- Self-closing option coming soon!
- Manual lift, manual close standard.
- Mounting instructions include a template for drilling through post.
- Cylinder rated for 10,000 cycles.
- Handrail kit coming soon!

Telescoping Swing Gate

- Adjusts to fit opens from 18" to 36".
- Can be installed on guardrail or handrail (2" O.D. max), regardless of brand.
- Can be inverted to swing either left or right.
- Springs designed for over 1 million cycles.
- Self closing.
- **MEETS OSHA REQUIREMENTS.**



PickerPal gate



Great 360 degree mezzanine protection



Bumper style

Mezzanine Safety Gates

We have five different styles of Mezzanine gates available to meet your needs — all are designed with fall protection per OSHA guidelines!

PickerPal Mezzanine Gates

- 6 self closing arms, operate independently.
- 6' or 8' width.
- Includes 8' tall rack frames and height limiter.
- **MEETS OSHA & IBC REQUIREMENTS.**

SafetyMezz360

For mezzanines or pick modules.

- Comes with 60" or 100" clear opening.
- Includes 4" safety toeboard.
- **COMPLIES WITH OSHA AND ANSI STANDARDS.**
- Utilizes a counter-balanced gate system and includes a slam-proof design.
- Easy to install and allows for one-handed operation.

Pallet Gate with Bumpers

- Standard Sizes: 60" or 72" clear opening width and clear opening height up to 84", includes gate columns, three (3) springs per gate, housed within hinge pivot.
- Teardrop Impact Bumpers: High-impact, ABS bumpers with 3" projection. Black.
- Specifications: High-impact, ABS adjustable 4" toe boards.
- **MEETS OSHA REQUIREMENTS.**

Mezzanine Gates



Horizontal sliding gate



Vertical lift gate

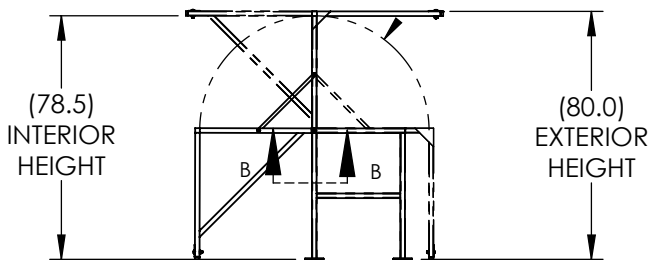

Pivot gate – closed

Mezzanine Gates

The Horizontal Sliding Gate and the Vertical Lift Gate are designed to be durable, productive, provide the same protection as your railing systems, and meet federal OSHA requirements for standard railings.

- Easily slides open and closed.
- Manufactured to specific width requirements.
- Factory welded steel framework.
- Gates are 42" high, with one mid-rail and 4" toeboard.
- Electric or pneumatic operation available with remote control. Call for details.
- Easy Installation.
- **MEETS OSHA REQUIREMENTS.**



Pivot Gate

Single or Double width gates.

- Choose from 60", 65", 72" 96" or 120" clear opening.
- All welded tubular steel frame.
- Easily pivots to up or down position.
- Requires only 10-20 lbs. of lift force.
- Made to order to fit your specific opening.
- Ships mostly assembled – minor assembly required upon receiving and simply anchor to mezzanine floor.
- Adjustable kickplate and rubber feet.
- **MEETS OSHA REQUIREMENTS.**



Flat Top



Dome Top

Blue Light

Increase warehouse safety by adding a Blue Light to increase visibility and awareness of fork trucks.

- Mount to fork truck (front or rear).
- Hardware and 12" wire lead provided.
- 5 bright LED lights create 400 Lumens of bright blue light in the path of the fork truck (subject to change).

Fork Extension Bracket

Stop looking for a place to put your fork extensions!

- Holds up to 3 fork blade extensions.
- Can be wall or rack mounted, hardware not included.
- Solid high tensile steel construction for long-lasting durability.
- Measures 6" wide x 8" tall, hook extends out 5".
- Powder coated Savety Yellow.

Bollard Sleeves

- Made using a 1/8" thick High Density Polyethylene plastic, the sleeves are designed to absorb impact, be solvent resistant, resist fading in ultraviolet light, and can withstand extreme temperatures.
- On the Flat Top sleeves, 3M reflective stripes increase visibility.
- Mounting kit included at no charge.
- Dropship direct to your customer.
- Available in 4½" – 12¾" diameter.
- Sleeves can be cut to size at no charge.
- Choose from Flat Top or Dome Top sleeves.
- Sleeves slide on quickly and easily, no hassle.

Flat Top		Dome Top	
I.D.	Height	I.D.	Height
4.5"	52"	4.5"	52"
4.5"	64"	4.5"	64"
7"	52"	7"	52"
7"	60"	7"	60"
7"	72"	7"	72"
8-7/8"	72"		
8-7/8"	60"		
11-1/3"	60"		



Our Products at Work

Application Photo Gallery

Applications are indispensable when you consider the value of assets that need protection.

Our products secure many areas and stand guard to protect the facilities and employees of small, medium and large corporations.

If you have an application that you would like to discuss, we will help you find the best solution to fit your needs. We have the experience and resources to assure that you and your facility will remain protected.

At "SAVE"ty Yellow Products it's our mission to help SAVE YOUR ASSETS!



Guarding equipment



Door track guards



Guarding battery racks



Guarding electrical panels



Guarding refrigeration



Guarding employees behind drywall

"Save"ty[®] Yellow Products



Protect vulnerable access points

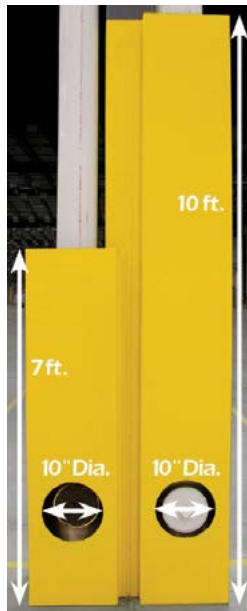

Custom made



Building Column & Downspout Guard Rail



See pages 4 and 21



See page 15

Our Products at Work



Perimeter protection and rack guard



Drive thru rack protection



Lift up and out of the way



Strong end of aisle rack protection with offset baseplates

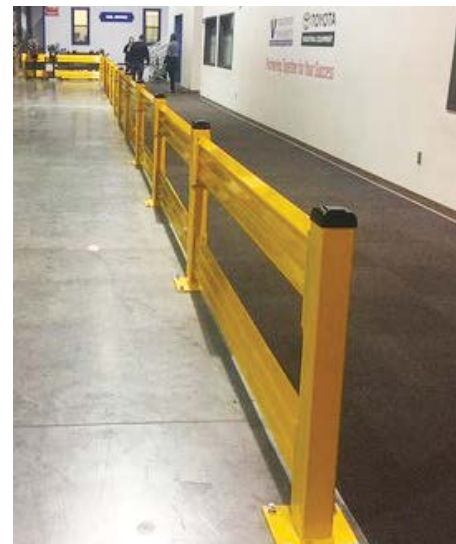

Create a safe passage



We Deliver MORE Than Just Our Products!

We Deliver PEACE OF MIND!

Without "Save"ty Yellow Products, you may be worrying more about safety issues than you should be.

You have invested in your business – equipment, inventory, and especially employees – to meet the needs of your customers. You don't want unexpected safety issues to cause you downtime, added expense, or personal injury. Let "Save"ty Yellow Products help protect your business and **SAVE YOUR ASSETS!**

Our products have been shown to protect employees, facilities, products, and equipment from impact with fork trucks, and do it better and at a lower cost! We have supplied products to facilities used by some of America's finest companies, including Amazon, U.S. Foods, Adidas, Home Depot, and General Electric.

Built on the foundation of "The Original **LIFT-OUT Sleeve Design**" guard rail system, "Save"ty Yellow Products has branched out to include facility protection, hand

rails, safety gates and more. We continue to develop new products to meet safety needs and also customize products for specific applications.

The products we manufacture are made in America, powder coated with certified lead-free paint, and stocked in Illinois.

We invite you to enjoy the peace of mind that comes from knowing that your business is protected 24/7. "Save"ty Yellow Products can help you do that!

– The Gentile Family

The little things matter...



In Stock



Quality



Packaging



New Additions

NEW FOR 2020

Rolling Gate



Economical **Rolling Gate** for customers on a budget. See page 13.

Fabric Gate

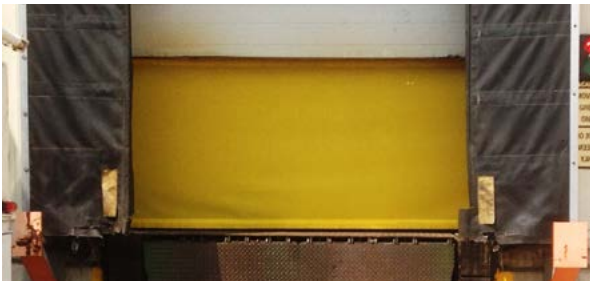

Retractable **Fabric Gate** for customers who want to let in a little air and have security at the same time. See page 14.

Rack Deflect

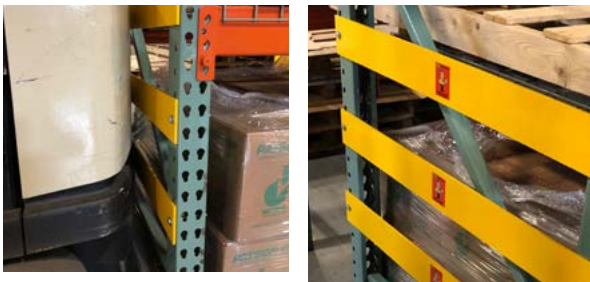

Rack Deflect was designed to block side frame damage. See page 11.

Pallet Guide



Pallet Guide steers pallets into place without hitting the rear of the frame. Also works as a frame brace. See page 11.

Dock Stop HD



Dock Stop HD, our strongest Dock Gate yet. See page 17.

Back of Rack



Back of Rack stops product from being pushed off the rack. See page 12.

Roofguard



Roofguard See page 13.

Pivot Gate



Pivot Gate creates ideal mezzanine protection while allowing for easy pallet loading and unloading. See Page 23.



Double corner post

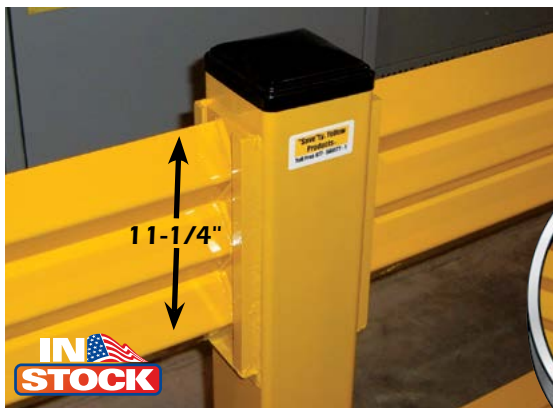

Inline post



Optional offset end post

Ribbed Rail "Stand Guard"

Our most popular item: the **Stand Guard** ribbed rail. "The Original **LIFT-OUT** Sleeve Design" reduces installation cost by half!

- Sleeves are welded to posts, **no costly brackets as an afterthought.**
- 4" posts with 10" x 10" x 1/2" base rated for impacts up to 10,000 lbs at 5 mph.
- 5" posts with 10" x 10" x 5/8" base rated for impacts up to 12,000 lbs at 5 mph.
- Painted steel caps are included with posts.
- Post heights: 18", 26" & 42".
- 10-gage, high-tensile steel rails fit either post.
- Rails are 2' through 10' in 1' increments.



FULLY WELDED SLEEVES!

Offset posts are in stock.



Guard Rails



Lite ribbed guard rail



Create a pedestrian walkway with Stand Guard Lite

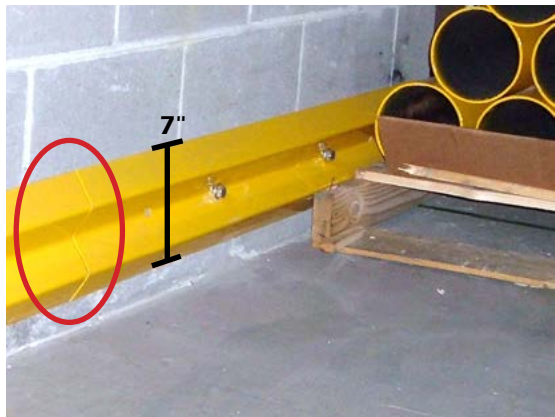

Quick Release LIFT-OUT design

Lite Duty Guard Rail

"Stand Guard" Lite is designed for powered and manual stackers, electric pallet trucks, steel carts & hoppers, etc.

- A great alternative to high strength guard rail, with *The Original LIFT-OUT Sleeve Design*.
- Designed for heavy impacts up to 5,000 lbs. at 5 mph.
- 4" posts, 18" & 42" high, with 8" x 8" x 1/2" base.
- 14-gage, high-tensile steel rails are 2' through 10' in 1' increments.



Wall Bumper Rail

Durable Steel Protection

- Mounts directly to wall on 16" centers
- 14 gage steel
- 2', 4', 6', and 10' lengths available
- Eliminate posts along perimeter walls
- Can be overlapped to reduce cutting in the field

Twin Rail

Durable steel protection

- Our original Twin Rail design from 2003 re-styled with stronger rails. It comes standard with **LIFT-OUT** rails that offer holes for bolting together if desired.
- Create a mezzanine gate with twin rail, utilizing the Quick Release LIFT-OUT design.
- 44" tall posts with a powder coated steel cap.
- 3" x 3" posts, with a 6" x 6" x 1/2" base plate is rated for 4000 lbs. impact at 4 mph.
- 4" tall x 2" wide rail is 11-gage high-tensile steel.
- Top rail is 42" high
- **MEETS OSHA REQUIREMENTS.**
- Available in 4', 6', 8' and 10' lengths.



Slim & short models



Eagle™ – Velcro™ strap



The Original **LIFT-OUT** Sleeve Design is available in single-rail height



Building and Mezzanine Column Protectors

Prevent damage to building support columns or mezzanine columns. From Eagle™ Mfg.

- **SHORT** Model is 24" tall x 24" wide for 6", 8", 10" & 12" columns, Yellow or Red.
- **SLIM** Model is 42" tall x 12" wide for 4", 5", & 6" columns, Yellow.
- **STANDARD** Model is 42" tall x 24" wide for 6", 8", 9" Round, 10", & 12" columns. Yellow standard, Lime Green or Orange with reflective tape also available.
- **FASTENERS** Velcro straps.
- **SHIPPING POINTS** Five shipping warehouses.
- Impact Rating – 8000 lbs @ 5 M.P.H."



Style	Eagle™	Colors
SHORT	6", 8", 10", 12"	Yellow, Red
SLIM	4" - 6"	Yellow
STANDARD	6", 8", 9" Round, 10", 12"	Yellow, Orange, Lime Green
FASTENER	Velcro Strap	Black

Protect Your Building Columns & Downspouts with Stand Guard Rail

Our most popular item: the **Stand Guard ribbed rail**. All welded **DROP-IN, LIFT-OUT** design standard.

- Sleeves are welded to posts, **no costly brackets as an afterthought**.
- Post heights: 18", 26" & 42"
- Rails are 2' through 10' in 1' increments.



Column Protectors

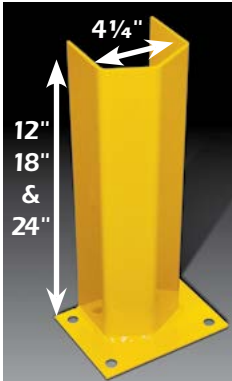

"V" face

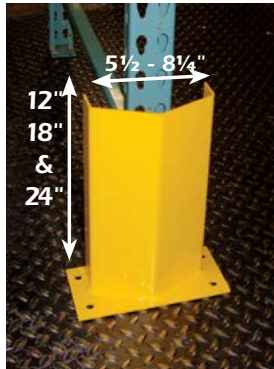

Seismic

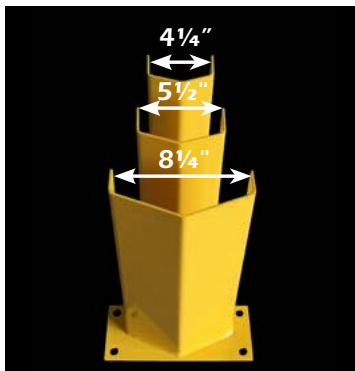

3 different heights & widths



Poly post protector



Corner Protector

**14,000
In Stock!**

Traditional Post Protectors

Traditional style post protection available in a "V" shape or formed face.

- Traditional style with four mounting holes.
- Choose from 12", 18", & 24" tall.
- Clear opening: 4 1/4".
- Anchors available upon request.

Seismic Post Protectors

Seismic post protectors in "V" face style designed to fit around seismic footplates.

- Clear opening of 5 1/2" or 8 1/4".
- Choose from 12", 18" or 24" tall.
- Base plate is 5" deep with four mounting holes.
- Anchors available upon request.

Poly Post Protectors

Easy snap on installation.

- Fits 3" x 1 5/8" or 3" x 3" rack.
- 8" tall x 5 1/2" O.D. wide.
- Stackable.

Corner Protector

- Protect corners.
- 4" x 4" x 18" tall.
- 4 mounting holes.
- Accepts 1/2" anchors.





Bolt On



Side mount



Closed top for food industry



Flush hardware



Bolt On Post Protectors

Bolt-on post protectors add strength to frame column to prevent costly rack damage.

- Available in 18" tall with a clear opening 3 1/8".
- 3/16" thick wall.
- Optional hardware to attach to rack frame.
- Add strength to your upright.
- Mounting hole inside 1/4" thick bull nose.
- Accepts 5/8" anchor (additional).



Side Mount Frame / Column Protectors

Stop damage at every level.

- Increase frame strength.
- No base plate to interfere when storing pallets.
- 3 1/4" clear opening.
- 12" and 24" tall with 2" hole spacing.
- Mounting hardware included.

Food Industry Closed Top Post Protectors

New food industry closed Top Post/Column Protector

- 24" tall with closed top.
- Side mount with open/notched back for first beam level.
- 3 1/4" clear opening.
- 24" tall with 2" hole spacing.
- Mounting hardware included.



Post Protectors



Outrigger post protector

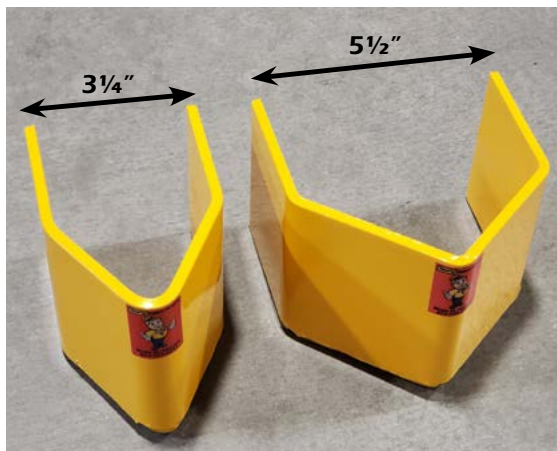

1/4" or 3/8" in stock



Post Protector No Base

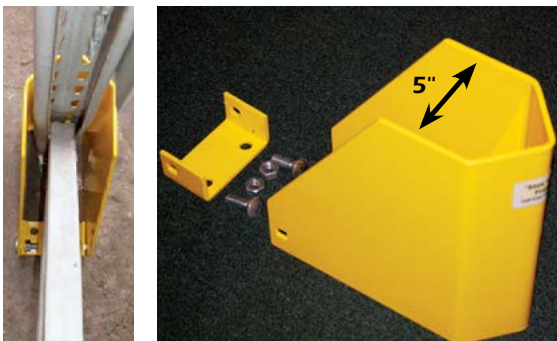

Patented

Outrigger Post Protectors

Designed specifically for Outriggers.

- Choose from 1/4" or 3/8" thickness.
- 4" tall x 3.25" clear, or 5.5" available.
- One mounting hole behind face.
- Accepts 5/8" anchors.



Post Protector No Base

- Formed from one plate of steel.
- Fits 4 1/4" or 5 1/2" clear opening.
- 3/4" clearance at the bottom.
- Accepts 1/2" anchors.



Hidden Anchor Post Protectors

Rack column post protectors eliminate base plates.

- Bolt down model with bracket hardware.
- Energy absorbing design anchors securely in front & behind frame.
- 12" tall by 9" deep.
- Inside dimensions are 5" x 5".
- TAPCON anchors available upon request.

End of Aisle Guards



Seismic option



Half curved end
(right hand pictured)



Double E.O.A.

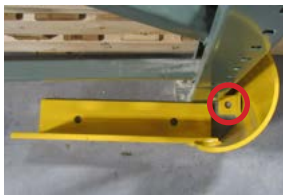

Three
mounting holes



Strong
corner protection



Rack Guard Round
Protects your warehouse



End of Aisle Rack Protection Curved End

Rack protection creates a visible guide through aisles and saves thousands in damage.

- Available in 36", 42" & 48", single or double ends.
- Custom sizes available.
- Curved end has an 8" I.D. x 12" tall.
- Choose floor angle thicknesses of 1/2", 3/8", and 1/4".

Super Duty Rack Guard

Three mounting holes.

- Our strongest rack guard yet with an extra mounting hole behind the curved face.
- 18" long with 6" x 4" x 1/2" steel angle.
- Has two mounting holes on the angle and one behind the nose.

Rack Guard Round

Solid welded construction.



- Fits snug to frame.
- Three 1/2" thick feet create an overall height of 5".
- Accommodates seismic foot plates up to 8" deep.
- 36", 42" or 48" O.A.L., with closed ends.
- Custom sizes available.

Pallet Stop

Prevent wall and product damage.

- 18" long x 5" tall, centered between rack frame, protects two skids at the same time.
- Anchors to the floor with two legs on either side of frame.
- Mounting feet may be mounted against the wall / Plastic end caps optional.



Rack Deflect and Pallet Guide



Reinforces rack and protects from impact



Flush hardware



Use as a pallet guide, reduces rack damage



Pallet guide or rack reinforcement

Rack Deflect

Prevents potential damage to crossbars by creating a barrier between the crossbars and forklifts.

- 4" tall x ¼" thick steel bars
- Steel bars can be stacked to create ½" thickness for additional strength.
- Available in 42" and 48"
- Mounted flush using double-end stud and weld nut so that nothing 'catches' on the hardware (see image below).
- Easy installation.
- Multiple bars can be used as bracing for the rack, providing reinforcement to the rack.



Pallet Guide

Prevents potential damage to crossbars and rack corners from pallets by creating a guide for pallets.

- 4" tall x ¼" thick steel bars.
- Available in 42" and 48".
- Mounted flush using double-end stud and weld nut so that nothing 'catches' on the hardware (see image below).
- Multiple bars can be used as bracing for the rack, providing reinforcement to the rack.
- Hardware included.

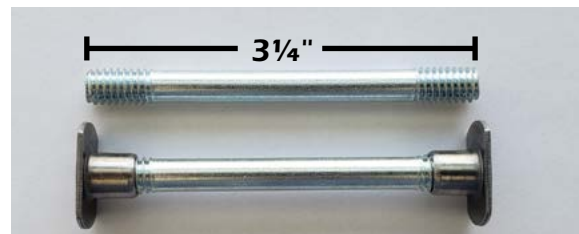

Flush mount hardware

Rack Protection



Front tab removes pressure from hardware

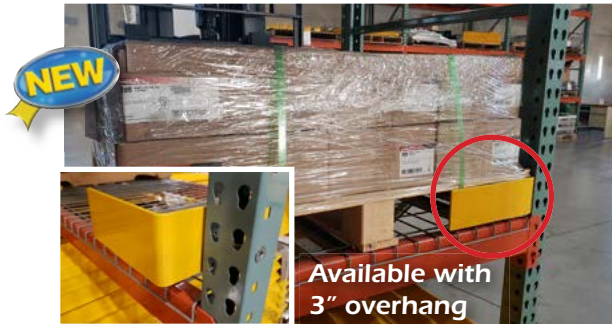

Pallet Guide / Stop

- Two products in one! – Keeps flue space clear and prevents damage to walls behind rack.
- 4" tall x ¼ thick steel bar with 10" return
- Available in 42", 45" (42" with 3" overhang), 48", and 51" (48" with 3" overhang).
- Mounts flush to double-end stud and weld nuts so that nothing "catches" on the hardware – see bottom of page 11 for hardware.
- Easy installation – hardware included.
- Creates additional reinforcement for the rack.
- Available without rear stop – see page 11.



Back of Rack

Designed to stop employees from pushing a skid off the back of the rack.

- High tensile steel brackets are 10 gage and are bolted to frames.
- Strong horizontal braces are secured in place with a ½" thick pin.
- Cut installation costs in half because there is no need for heavy netting, or the extreme hassle of netting installations.
- Low maintenance compared to broken straps, broken mesh panels and torn netting.
- Bracket measures 6" off the frame.
- This 10 gage thick brace is 4" tall, 97½" in length and is formed into a "C" channel for strength. See side profile above.
- ½" bracket hardware included.
- Use multiple braces for loose carton areas.
- Stocked in 8' sections, covering two pallet positions.
- Can be used in a back-to-back rack design to protect product from damage.



Perimeter Protection

Rooftop Perimeter Protection (Roofguard)

Roofguard is a versatile, rooftop fall protection system

- Free-standing, non-penetrating system with lightweight base plates.
- Can be used in both permanent and portable applications.
- Fast and easy installation – no drilling or special fasteners required.
- Available in 6', 8', and 10' handrail sections.
- **MEETS OSHA REQUIREMENTS.**
- Wind load tested.
- Can also be used on metal roof systems.



Interior Perimeter Protection

Perimeter protection products can save you thousands from lift trucks bumping into walls, door tracks, water and electrical pipes. Protect your facility today for much less than the cost of damage.



Fabric Savety Gate

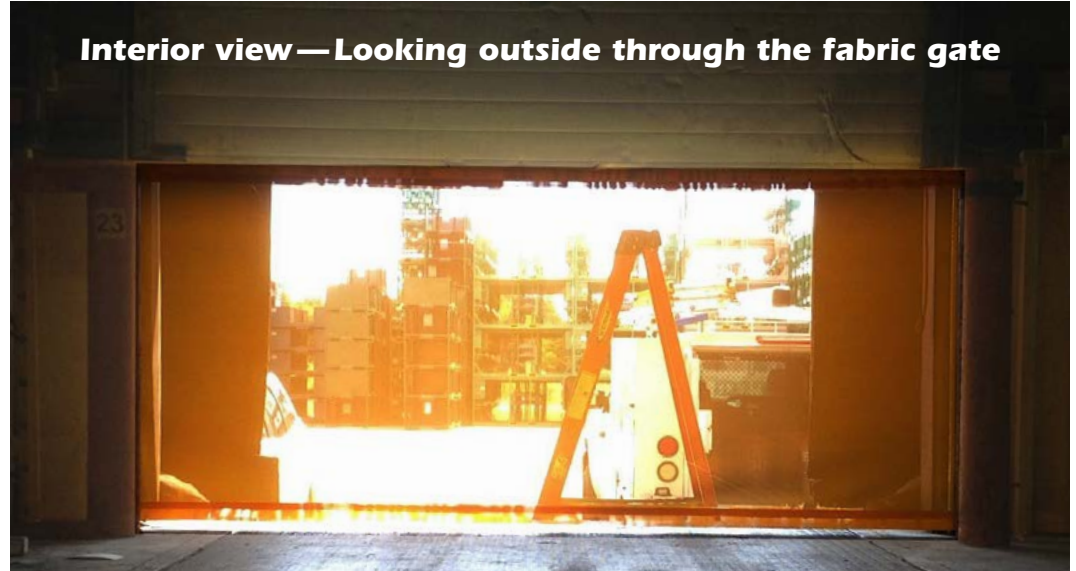

Our Fabric Savety Gate is perfect for dock doors that are often open. The Fabric Gate protects against unwanted visitors, insects, birds, and debris from entering the work area while allowing air to flow through. Our design allows for easy operation, requiring just 3 lbs of pull force to extend the gate. A locking feature prevents unwanted entry and theft.

- Accommodates doors from 8' – 16'
- High visibility
- Breathable fabric lets air circulate
- Small gap at base of the gate
- Easily retracts, requiring only 3 lbs of pull force



- Ratchet mechanism controls tension
- Locking feature included to prevent unwanted entry
- 48" tall
- **MEETS OSHA REQUIREMENTS.**
- Impact rating — 1000 lbs @ 4 M.P.H.

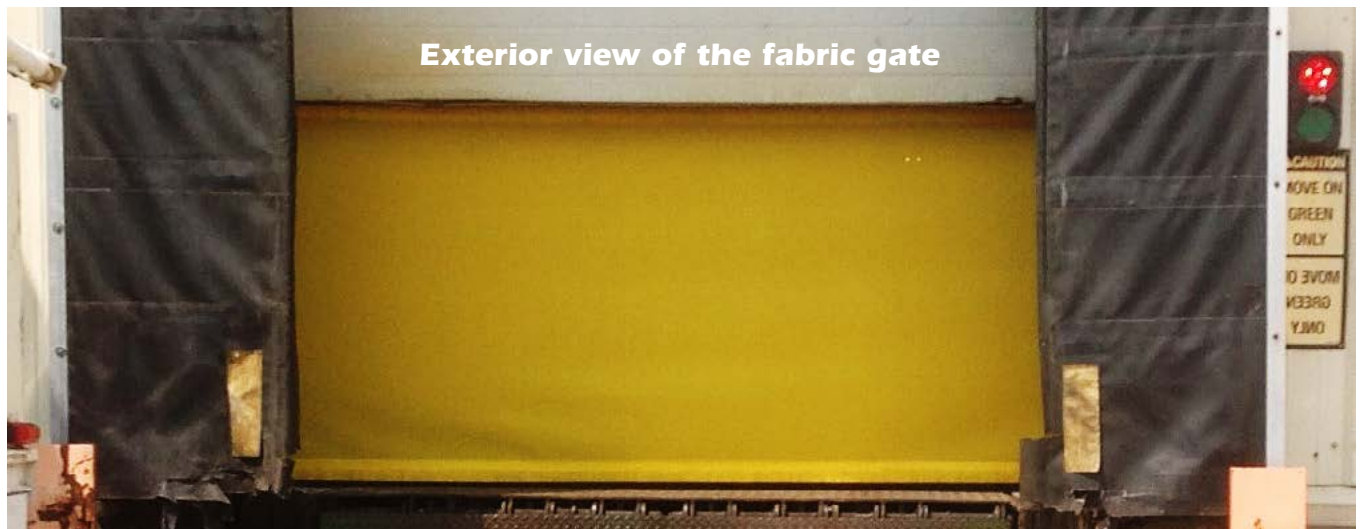

Dock Gates



Rotating gates: widths from 4' to 14'



Open dock



Locking Caster

Interior View



Exterior View

Rotating Dock Gate

Provides security, creates awareness and fall protection.

- Mounts over a 42" tall bollard which is required.
- Choose widths from 4' to 14'.
- Install two gates to meet in the center to accommodate space restrictions if needed.
- Add an optional bollard with eyelet at the opposite end for security.



Rolling Dock Safety Gate

Permits safe access in and out of the loading dock area with easy access and no lift and pinch hazards.

- Available in 8', 10', and 12' sizes.
- Durable 1.66" O.D. steel.
- Powder coated safety yellow.
- **MEETS OSHA REQUIREMENTS.**
- Rolling design eliminates lifting and pinch hazards.
- Mounting hardware optional.
- Locking caster stops drift.
- Easy installation – anchor base in minutes and you're done.



Dock Stop Lite



Patent Pending



CREATE A REAL BARRIER

- Stop fork trucks from driving or backing off the dock
- Dock Stop includes two rotating arms
- Includes two 42" bollards with 10" x 10" x 1/2" base plates
- Locking slide bars with locking pin
- Impact rated for 4000 lbs at 4 mph
- 8', 9', 10', 11' and 12' door sizes in stock
- Built in height-levelers, so arms meet in the middle every time
- Powder coated safety yellow
- Include reflective 'Stop' signs



Slide Bar Handle and Locking Pin



Dock Stop Heavy Duty

OUR STRONGEST DOCK GATE EVER! DOCK STOP *HD*

- Oversized 12" x 12" x 5/8" base plates with gussets for strength
- No pinch points when gate is closing
- 5" steel posts powder coated steel caps
- Robust 1" pins support gate arms
- Adjustable wrap around plate bolts to post to support gate arms
- Reinforced cross bar for strength behind panels
- 42" tall
- **MEETS OSHA REQUIREMENTS.**
- Impact rating — 10,000 lbs. @ 5 M.P.H.



Patent Pending

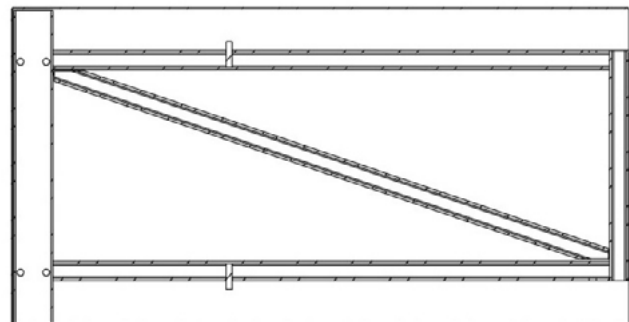

Reinforced Cross Bar



Dock Door Gates

Ideal for overhead doors. Great visibility to prevent accidents.

The "Save"ty Yellow Dock Gate is fabricated and bolts to post creating visibility. It is an economical and simple solution to comply with OSHA fall protection.

- Available in an 8', 10' and 12' clear opening.
- All sizes in stock.
- 42" tall at top of rail.
- New locking-pin design prevents gate from dropping.
- Air actuation cylinder holds gate open during deliveries or shipments.

Lift Gates: 8', 10' & 12' clear opening **▪ MEETS OSHA REQUIREMENTS.**

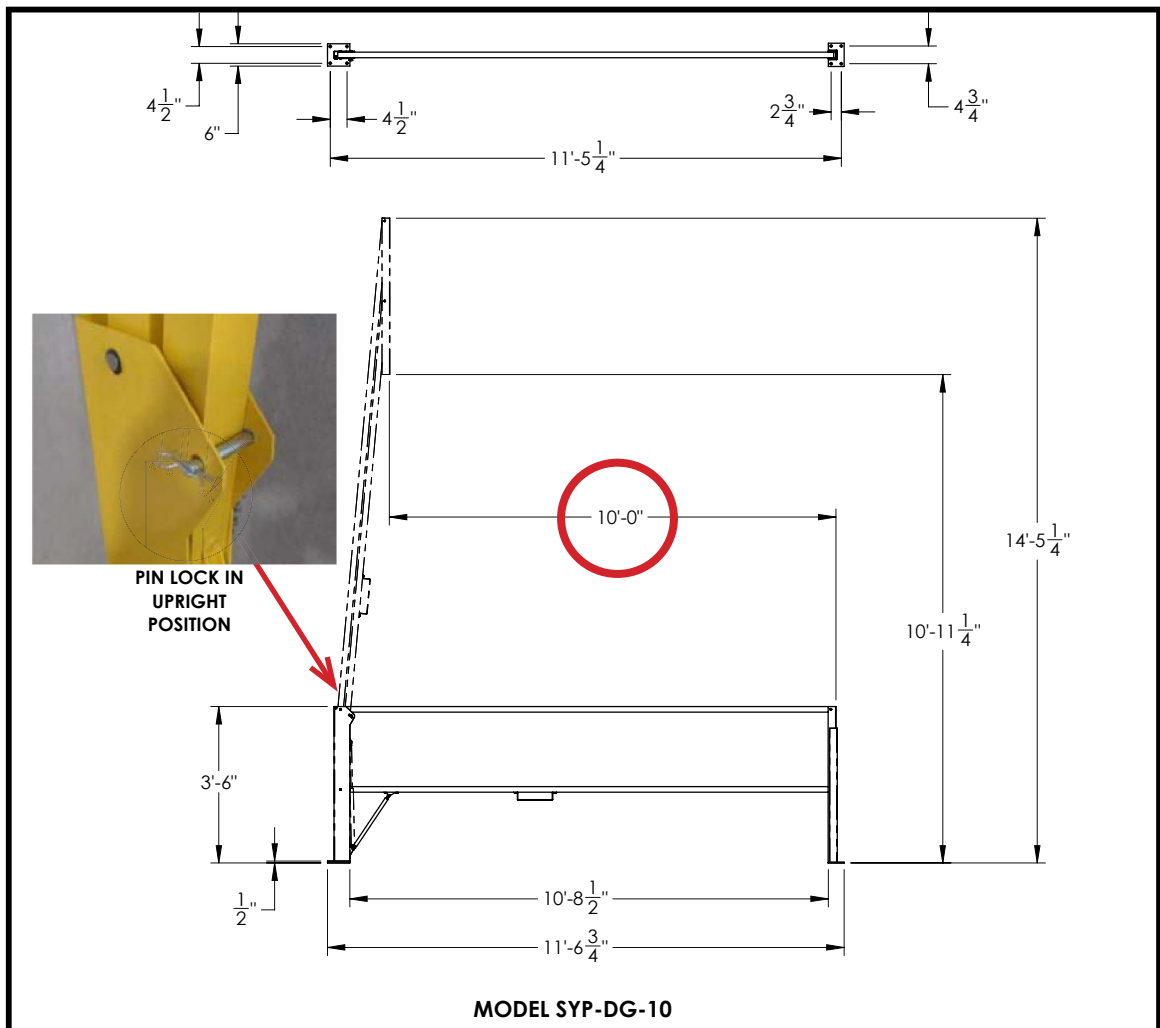

Hand Rails and Door Track



Indoor



Outdoor

Hand Rails

Modular hand rail protects employees from entering areas that are unsafe.

- Rails are powder coated yellow for long lasting durability.
- Easy installation, simply assemble and anchor down.
- Easy replacement of damaged sections or relocation.
- Stocked sizes: 4', 6', and 8' sections; can be cut down in the field.
- 1.66" O.D.
- **MEETS OSHA REQUIREMENTS.**
- 42" tall standard, ADA available.
- Fittings for mezzanine installation available.
- 1/8" kick plate (4" x 2") – In Stock.

Galvanized cast iron fittings

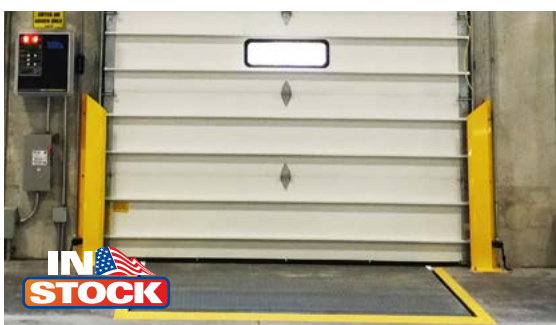

Door Track Protectors

Door Track protects overhead door track from damage while placing or retrieving pallets.

- Available with or without safety bevel.
- Eliminates expensive service calls for door repair.
- Available without baseplate.
- Standard duty for fork truck and commercial applications.
- Full 7" depth, up to 14" available.
- 36" and 48" tall in stock.
- 3/16" material, 1/4" base
- 1/4" available

Bollards



Stand Guard square bollards



White Reflective Band Available



Direct bury bollards

Steel Bollards

Steel bollards protect a variety of facility assets.

- Surface mount to concrete or Direct Bury.
- **Economy** 4.5" O.D., Yellow or Red, 5.5" O.D., Yellow only, 24," 36" or 42" tall.
- **Standard** 4.5" O.D. 42" tall, Yellow with black plastic cap; or 6.5" O.D. 24", 36" or 42" tall, Yellow with welded top, available with welded eyelet.
- **Direct Bury** 5.5", 6.5" & 8.5" O.D. 84" tall, Yellow.
- **Square Bollard** 4" square tube. 42" tall with painted steel cap.
- White reflective band available on any size bollard.

SAFETY PRODUCTS
LEAD FREE PAINT
MADE IN U.S.A.



We Have Your Bollards! Ready To Ship!

FAST DELIVERY

SURFACE MOUNT				
OD	HEIGHT	BASE	COLOR	TOP
4.5"	24", 36", 42"	8x8x¼	Yellow	Plastic cap
5.5"	24", 36", 42"	8x8x¼	Yellow	Plastic cap
6.5"	24", 36", 42"	9x9x½	Yellow	Welded
IN GROUND BOLLARDS				
OD	HEIGHT	BASE	COLOR	TOP
5.5"	84"	NONE	Yellow	OPEN
6.5"	84"	NONE	Yellow	OPEN
8.5"	84"	NONE	Yellow	OPEN

POWDER COATED TOUGH™



Safety Swing Gates



Great for stair openings



Double gate has built-in stop



Gate rotates 90° to open and stays upright until closed



Safety Swing Gates

Ideal for stair openings, ladders and platforms. The "Save"ty Swing Gate bolts to existing rail opening to provide a one-way, self-closing gate. It is a simple and economical solution to comply with OSHA.

Single & Double Gate

- Each gate has 2½" adjustability.
- Double Gate has built in stop.
- Single Gate requires a post for strike plate.
- Designed to fit hand railings.
- **MEETS OSHA REQUIREMENTS.**

Swing Gate No.	Fits Clear Opening	Wing Gate Part #	Fits Clear Opening
SINGLE GATE		DOUBLE GATE	
SYP-PS-15	14" - 17.5"	SYP-PS-9D	16" - 22.5"
SYP-PS-18	17" - 20.5"	SYP-PS-12D	22" - 28.5"
SYP-PS-21	20" - 23.5"	SYP-PS-15D	28" - 34.5"
SYP-PS-24	23" - 26.5"	SYP-PS-18D	34" - 40.5"
SYP-PS-27	26" - 29.5"	SYP-PS-21D	40" - 46.5"
SYP-PS-30	29" - 32.5"	SYP-PS-24D	46" - 52.5"
SYP-PS-33	32" - 35.5"	TELESCOPING GATE	
SYP-PS-36	35" - 38.5"	SYP-TEL	18" - 36"
SYP-PS-40	39" - 42.5"		
SYP-PS-44	43" - 46.5"		
SYP-PS-48	47" - 50.5"		

Lift A Gate

- Bolt to any standard guardrail, regardless of brand.
- Available in 36", 42", and 48"
- Self-closing option coming soon!
- Manual lift, manual close standard.
- Mounting instructions include a template for drilling through post.
- Cylinder rated for 10,000 cycles.
- Handrail kit coming soon!

Telescoping Swing Gate

- Adjusts to fit opens from 18" to 36".
- Can be installed on guardrail or handrail (2" O.D. max), regardless of brand.
- Can be inverted to swing either left or right.
- Springs designed for over 1 million cycles.
- Self closing.
- **MEETS OSHA REQUIREMENTS.**



PickerPal gate



Great 360 degree mezzanine protection



Bumper style

Mezzanine Safety Gates

We have five different styles of Mezzanine gates available to meet your needs — all are designed with fall protection per OSHA guidelines!

PickerPal Mezzanine Gates

- 6 self closing arms, operate independently.
- 6' or 8' width.
- Includes 8' tall rack frames and height limiter.
- **MEETS OSHA & IBC REQUIREMENTS.**

SafetyMezz360

For mezzanines or pick modules.

- Comes with 60" or 100" clear opening.
- Includes 4" safety toeboard.
- **COMPLIES WITH OSHA AND ANSI STANDARDS.**
- Utilizes a counter-balanced gate system and includes a slam-proof design.
- Easy to install and allows for one-handed operation.

Pallet Gate with Bumpers

- Standard Sizes: 60" or 72" clear opening width and clear opening height up to 84", includes gate columns, three (3) springs per gate, housed within hinge pivot.
- Teardrop Impact Bumpers: High-impact, ABS bumpers with 3" projection. Black.
- Specifications: High-impact, ABS adjustable 4" toe boards.
- **MEETS OSHA REQUIREMENTS.**

Mezzanine Gates



Horizontal sliding gate



Vertical lift gate

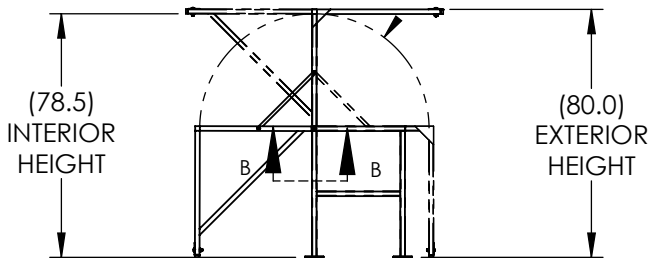

Pivot gate – closed

Mezzanine Gates

The Horizontal Sliding Gate and the Vertical Lift Gate are designed to be durable, productive, provide the same protection as your railing systems, and meet federal OSHA requirements for standard railings.

- Easily slides open and closed.
- Manufactured to specific width requirements.
- Factory welded steel framework.
- Gates are 42" high, with one mid-rail and 4" toeboard.
- Electric or pneumatic operation available with remote control. Call for details.
- Easy Installation.
- **MEETS OSHA REQUIREMENTS.**



Pivot Gate

Single or Double width gates.

- Choose from 60", 65", 72" 96" or 120" clear opening.
- All welded tubular steel frame.
- Easily pivots to up or down position.
- Requires only 10-20 lbs. of lift force.
- Made to order to fit your specific opening.
- Ships mostly assembled – minor assembly required upon receiving and simply anchor to mezzanine floor.
- Adjustable kickplate and rubber feet.
- **MEETS OSHA REQUIREMENTS.**



Flat Top



Dome Top

Blue Light

Increase warehouse safety by adding a Blue Light to increase visibility and awareness of fork trucks.

- Mount to fork truck (front or rear).
- Hardware and 12" wire lead provided.
- 5 bright LED lights create 400 Lumens of bright blue light in the path of the fork truck (subject to change).

Fork Extension Bracket

Stop looking for a place to put your fork extensions!

- Holds up to 3 fork blade extensions.
- Can be wall or rack mounted, hardware not included.
- Solid high tensile steel construction for long-lasting durability.
- Measures 6" wide x 8" tall, hook extends out 5".
- Powder coated Savety Yellow.

Bollard Sleeves

- Made using a 1/8" thick High Density Polyethylene plastic, the sleeves are designed to absorb impact, be solvent resistant, resist fading in ultraviolet light, and can withstand extreme temperatures.
- On the Flat Top sleeves, 3M reflective stripes increase visibility.
- Mounting kit included at no charge.
- Dropship direct to your customer.
- Available in 4½" – 12¾" diameter.
- Sleeves can be cut to size at no charge.
- Choose from Flat Top or Dome Top sleeves.
- Sleeves slide on quickly and easily, no hassle.

Flat Top		Dome Top	
I.D.	Height	I.D.	Height
4.5"	52"	4.5"	52"
4.5"	64"	4.5"	64"
7"	52"	7"	52"
7"	60"	7"	60"
7"	72"	7"	72"
8-7/8"	72"		
8-7/8"	60"		
11-1/3"	60"		



Our Products at Work

Application Photo Gallery

Applications are indispensable when you consider the value of assets that need protection.

Our products secure many areas and stand guard to protect the facilities and employees of small, medium and large corporations.

If you have an application that you would like to discuss, we will help you find the best solution to fit your needs. We have the experience and resources to assure that you and your facility will remain protected.

At "SAVE"ty Yellow Products it's our mission to help SAVE YOUR ASSETS!



Guarding equipment



Door track guards



Guarding battery racks



Guarding electrical panels



Guarding refrigeration



Guarding employees behind drywall

"Save"ty[®] Yellow Products



Protect vulnerable access points

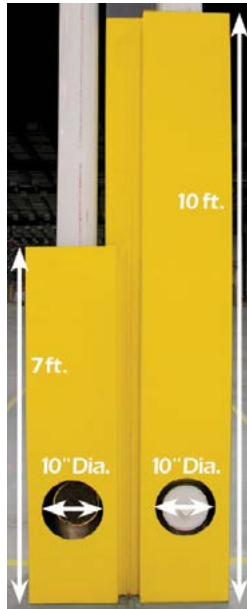

Custom made



Building Column & Downspout Guard Rail



See pages 4 and 21



See page 15

Our Products at Work



Perimeter protection and rack guard



Drive thru rack protection



Lift up and out of the way



Strong end of aisle rack protection with offset baseplates

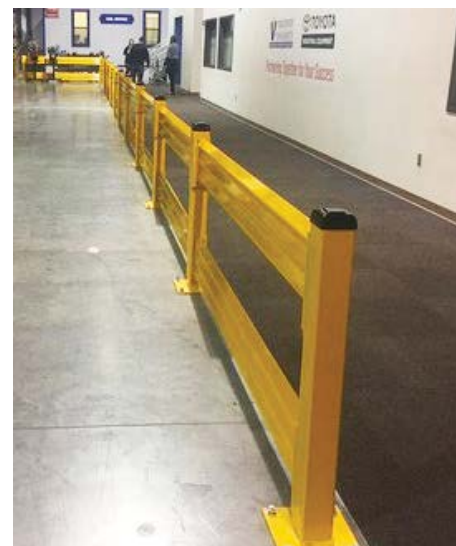

Create a safe passage